

# Interstate + Lakeland Lumber

*What Dream Homes Are Made Of®*

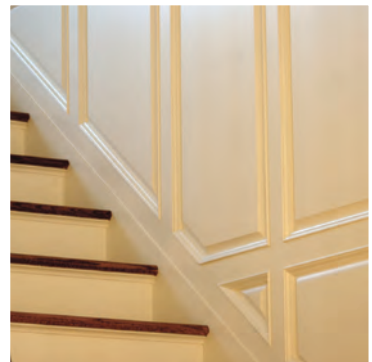

MOULDING & MILLWORK CATALOG

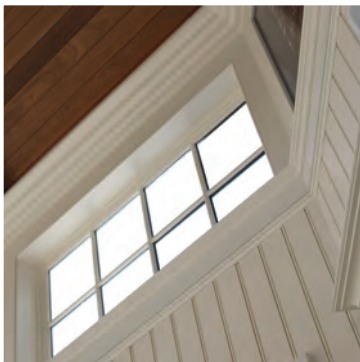
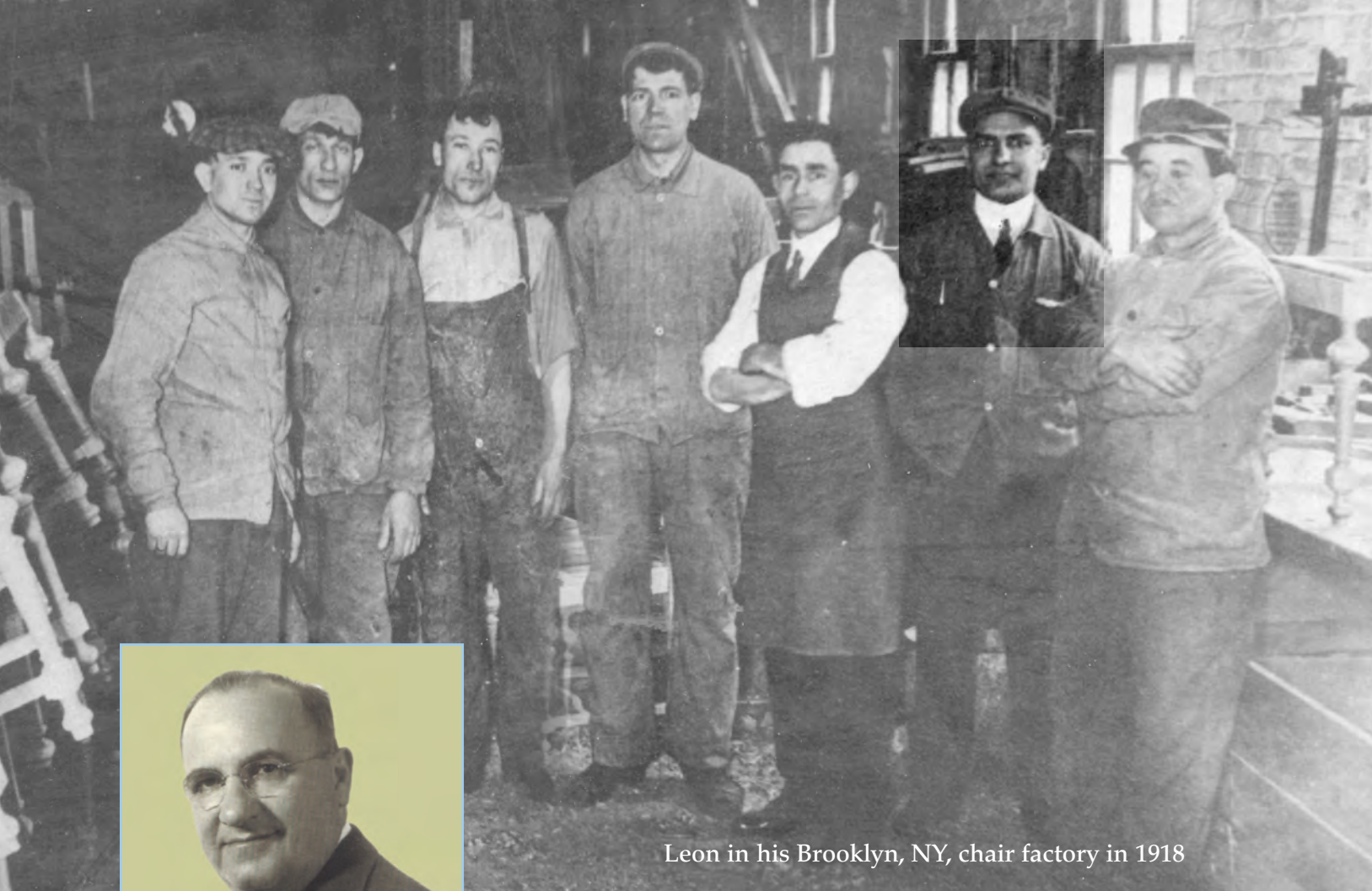

Leon in his Brooklyn, NY, chair factory in 1918



Leon Kahan 1889-1968



Leon's original woodworking tools displayed in Interstate Design Center · Greenwich, CT

# T R A D I T I O N

Leon Kahan, a young Romanian immigrant, mastered the art of wood carving at the turn of the 20th century and went on to found Interstate + Lakeland Lumber two decades later. Since 1922, Interstate + Lakeland Lumber has been supplying Westchester and Fairfield County's finest architects, designers, builders and contractors with quality millwork and building materials. Over the years, by establishing an impeccable reputation, Interstate + Lakeland Lumber has emerged as a leader and innovator in the architectural millwork field. This revised and improved catalog of moulding and millwork offers an updated collection of our stocking moulding profiles with over 100 new profiles. In addition, we have expanded our abilities to create exceptional custom architectural millwork projects. Whether it is 1922 or 2022 and beyond, traditional ideals and quality craftsmanship, with which Leon Kahan started Interstate + Lakeland Lumber, will continue to be the foundation of the IL Custom Millwork Shop.







# INSPIRATION

One of the innovative masters of modern architecture, Mies van der Rohe, said, "God is in the details." This revised IL Moulding and Millwork catalog is designed with that very thought in mind. As one flips through the pages, he or she will be able to select moulding profiles that, when grouped together, can create and inspire some of the most beautiful interior spaces. In addition to the hundreds of moulding profiles in this catalog, there is a section dedicated to Interstate + Lakeland Lumber's Architectural Millwork department. The combination of the moulding profiles, coupled with our ability to design and manufacture them, makes for a unique combination. I hope that as you turn through these pages of IL Mouldings & Millwork, the details will inspire you just as they inspire us.



Sheldon Kahan  
President

# TABLE OF CONTENTS

## ■ GREENWICH COLLECTION PROFILES

OVERVIEW	8 – 9
CASINGS	10 – 32
Casings, Casings with Back Bands, Back Bands, Plinths, Quirks	
BASEBOARDS	33 – 43
Baseboards, Basecaps, Shoe Mouldings	
CROWNS	44 – 80
Crowns, Fascia Boards, Dentil Trim	
CAPITOL MOULDING	81 – 84
SOLID CROWNS	85 – 86
PANEL MOULDING	87 – 92
CHAIR RAILS	93 – 98
Chair Rails, Wainscot Cap, Picture Moulding	
CUSTOM BOARDING	99 – 100
WINDOW STOOLS	101 – 102
EXTERIOR PROFILES	103 – 115
Balusters, Rails, Ext. Casings, Ext. Panel Moulds, Brick Mould, Ext. Crowns, Sub Sills	

## ■ CUSTOM MILLWORK

OVERVIEW	118 – 119
CAD & SHOP DRAWING	120 – 121
RESTORATION	122 – 123
EXTERIORS	124 – 125
CUSTOM PVC MILLWORK	126 – 127
RADIUS & CURVED WORK	128 – 129
INTERIOR SPACES	130 – 131
ARCHITECTURAL ELEMENTS	132 – 133
FRONT ENTRYWAYS	134
CABINETS	135
INDEX	136 – 139





**IL GREENWICH COLLECTION™**

# THE PROFILES





## **A Comprehensive Collection**

The IL Greenwich Collection™ is a comprehensive moulding program that is divided into profile categories based upon the product's application. To ensure that the proper mouldings are specified in your project, simply write the corresponding IL moulding number in your specifications, or in your architectural plans.

## **In Stock and Ready for Prompt Delivery**

Our 100,000-square-foot millwork distribution center, located in Bethel, CT, stocks all of the IL Greenwich Collection™ moulding profiles shown in this book. The stocking profiles are run in solid poplar substrate with machine-applied primer. This allows for greater stability of the IL product and prompt installation upon delivery. For exterior applications, such as cornice work, window and door trim, balusters and more, IL profiles are available in Spanish cedar with machine-applied primer.





### Custom Runs and Profiles

With lead time, any profile can be run in the material of your choice, including hardwoods, flexible moulding, MDF and PVC. We also boast an expansive collection of custom knives. A full catalog is available online ([www.interstatelumber.com](http://www.interstatelumber.com)) in the moulding section, which includes scaled versions of popular IL profiles as well as other custom profiles created for special projects. All IL patterns can be run in radius, elliptical, and pattern shapes for exterior and interior applications. Plus, the IL Custom Millwork Shop can match profiles or produce custom moulding to your specifications. Our knowledgeable and experienced staff can assist you in every phase of your moulding and millwork order to ensure that it is a complete success.

*Please note that the IL profiles shown in this catalog are representations of the actual mouldings we produce. Dimensional tolerances are closely held, but slight variations to actual shape may occur.*



Indicates a profile in our new Scaled & Graduated section, which offers the opportunity to create a unified look throughout the house when ceiling heights vary and a smaller or larger version of the same profile may be desirable.



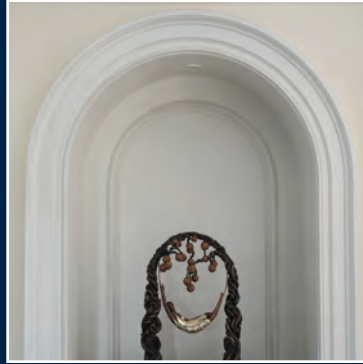





2" - 3"

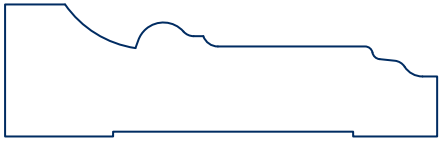

IL 255  
11/16 x 2 1/4

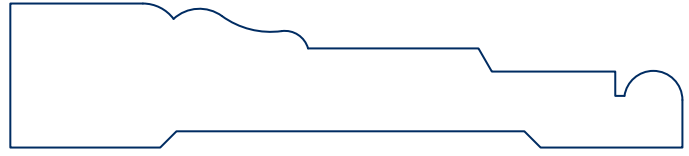

IL 227  
3/4 x 3 1/2

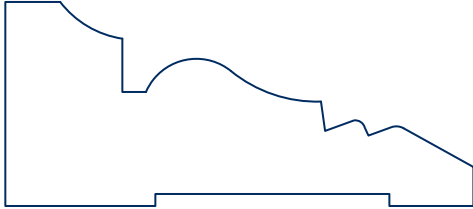

IL 254  
1 1/16 x 2 7/16



IL 288  
3/4 x 3 1/2

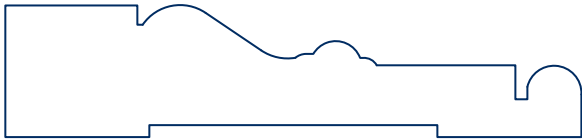

IL 242  
11/16 x 3

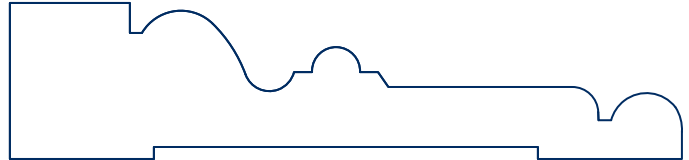

IL 201  
13/16 x 3 1/2

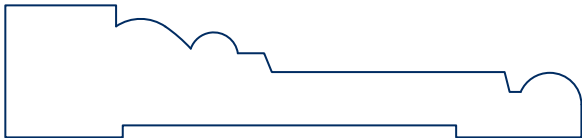

IL 207  
11/16 x 3

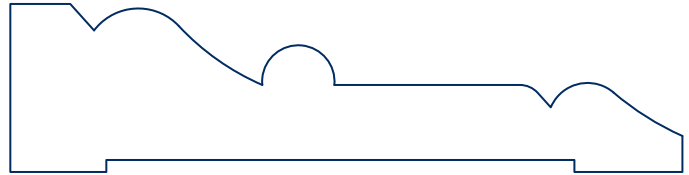

IL 214  
7/8 x 3 1/2

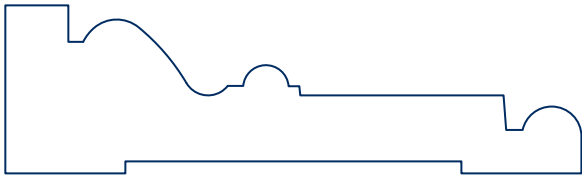

IL 246  
7/8 x 3

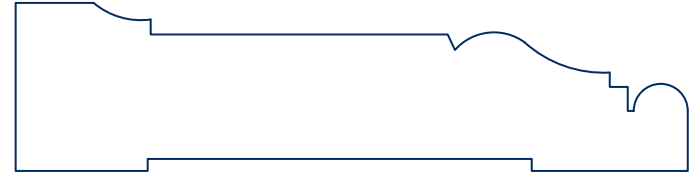

IL 241  
7/8 x 3 1/2

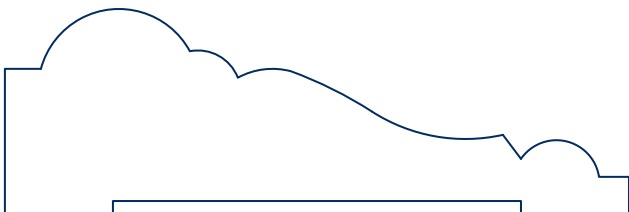

IL 236  
1 1/16 x 3 1/4

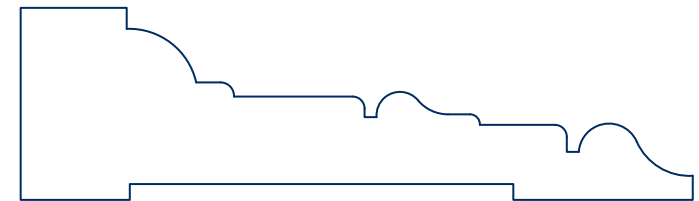

IL 204  
1 x 3 1/2





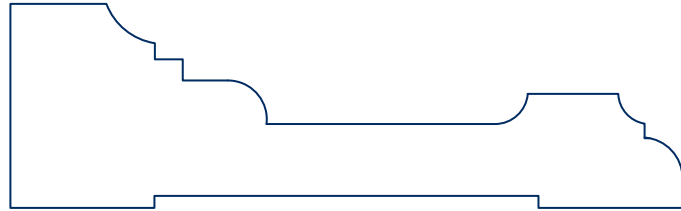

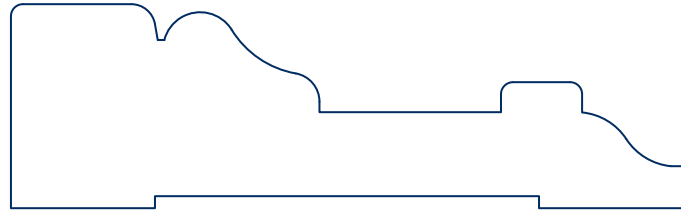

IL 202  
1 1/16 x 3 1/2

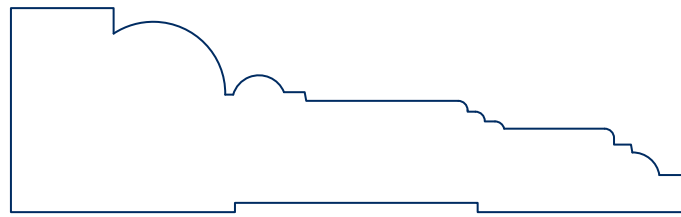

IL 244  
1 1/16 x 3 1/2



IL 289  
1 1/16 x 3 1/2  p.32

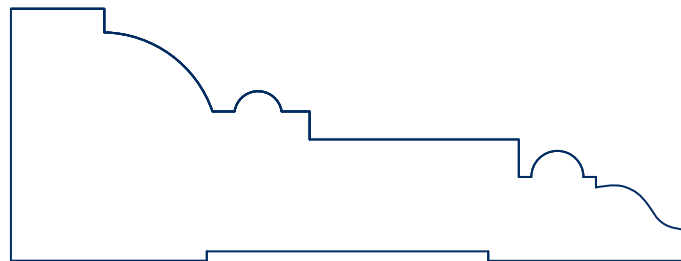

IL 290  
1 5/16 x 3 1/2

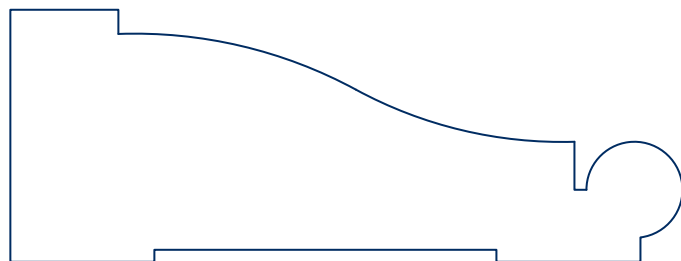

IL 234  
1 5/16 x 3 1/2

Profiles Shown 1:1

Greenwich, CT  
203.531.8050 914.939.2500

Bethel, CT  
203.748.5629

Newtown, CT  
203.364.0074

Stamford, CT  
203.348.3761

Westport, CT  
203.226.3321

Shrub Oak, NY  
914.245.5050



3"

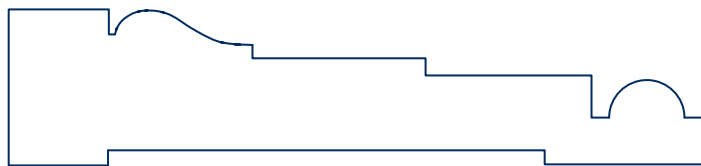

IL 239  
13/16 x 3 5/8

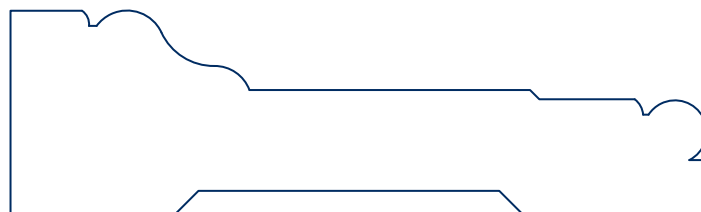

IL 225  
1 1/16 x 3 5/8

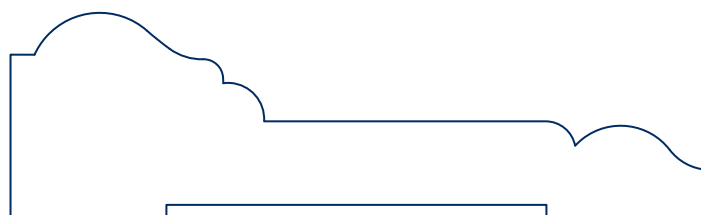

IL 238  
1 1/16 x 3 5/8

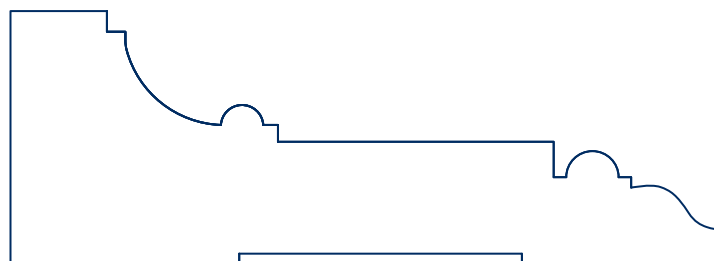

IL 291  
1 5/16 x 3 11/16

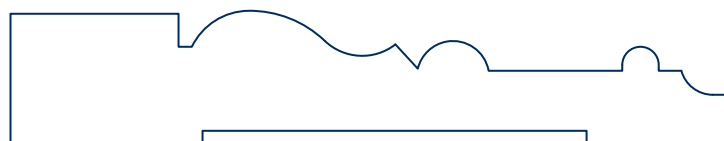

IL 213  
11/16 x 3 3/4



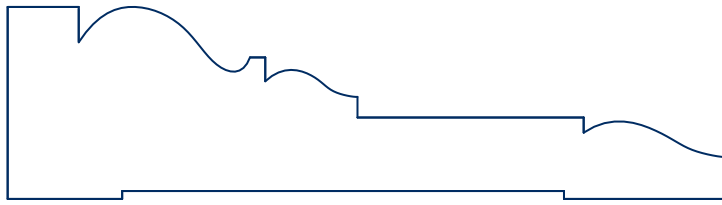

IL 292  
1 x 3 3/4

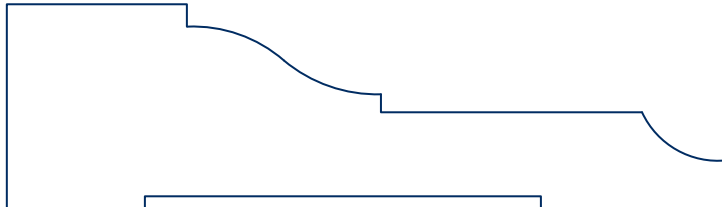

IL 232  
1 1/16 x 3 3/4

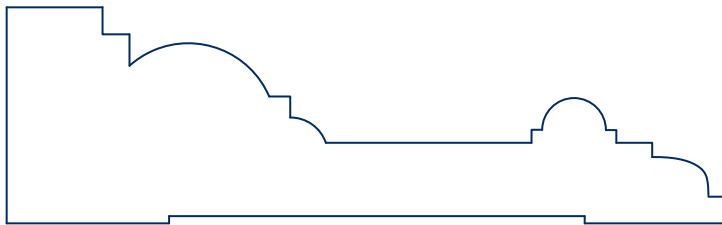

IL 293  
1 1/8 x 3 3/4

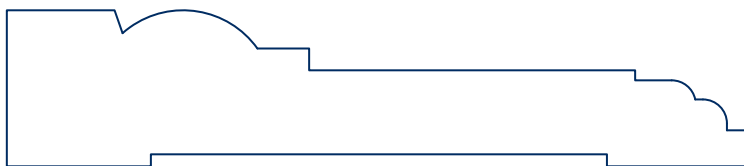

IL 217  
13/16 x 3 7/8

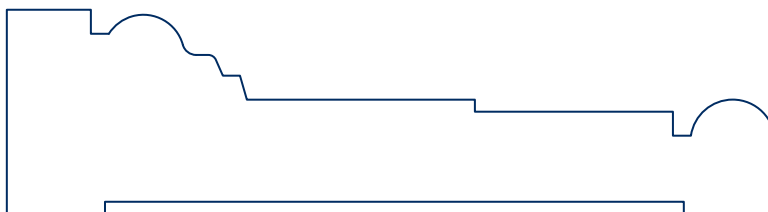

IL 240  
1 1/16 x 4

Profiles Shown 1:1

Greenwich, CT  
203.531.8050 914.939.2500

Bethel, CT  
203.748.5629

Newtown, CT  
203.364.0074

Stamford, CT  
203.348.3761

Westport, CT  
203.226.3321

Shrub Oak, NY  
914.245.5050





4"

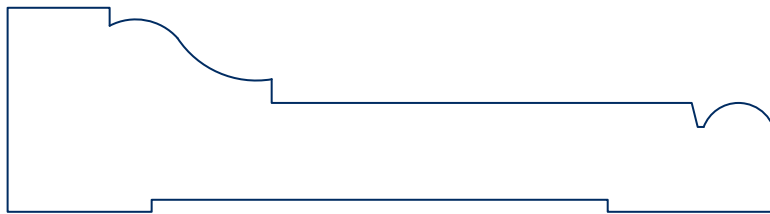

IL 223  
1 1/16 x 4

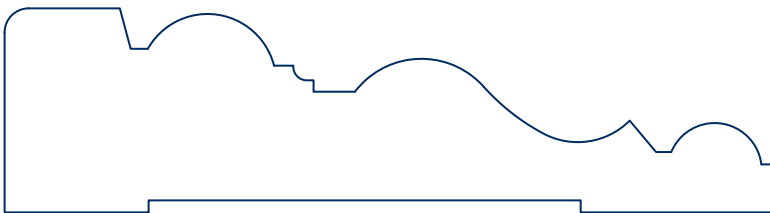

IL 205  
1 1/16 x 4

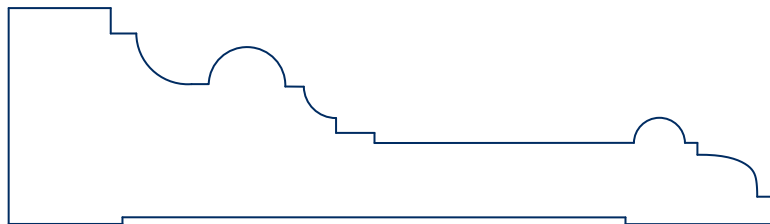

IL 294  
1 1/8 x 4

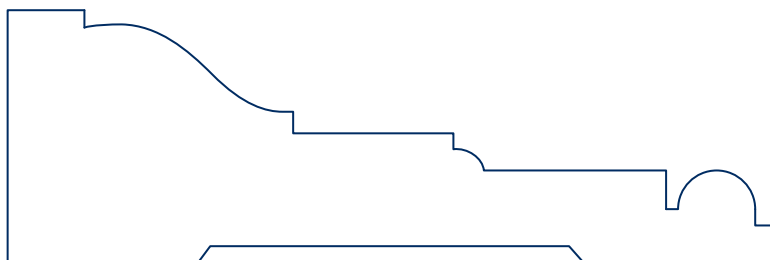

IL 295  
1 5/16 x 4

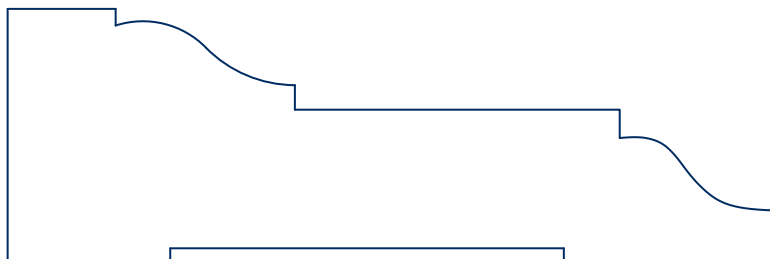

IL 296  
1 5/16 x 4



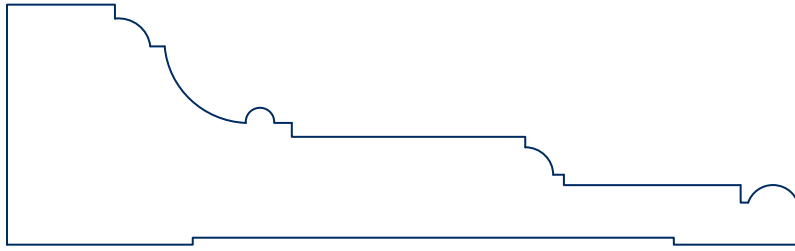

IL 297  
1 1/4 x 4 1/8

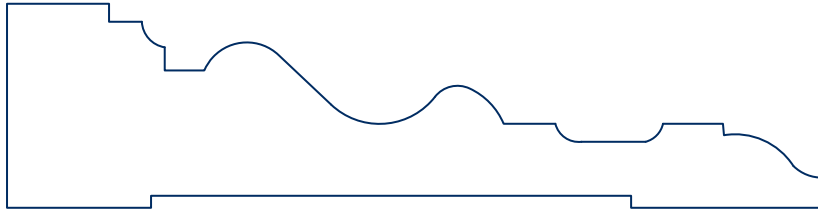

IL 203  
1 1/16 x 4 1/4

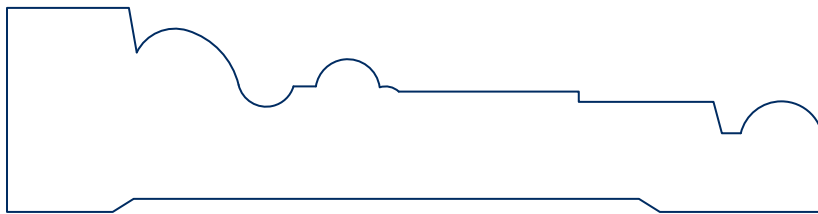

IL 224  
1 1/16 x 4 1/4

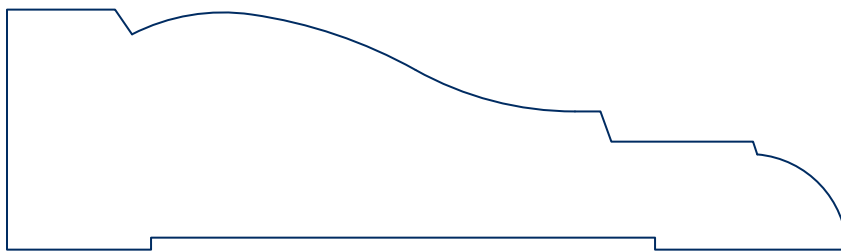

IL 250  
1 1/4 x 4 3/8

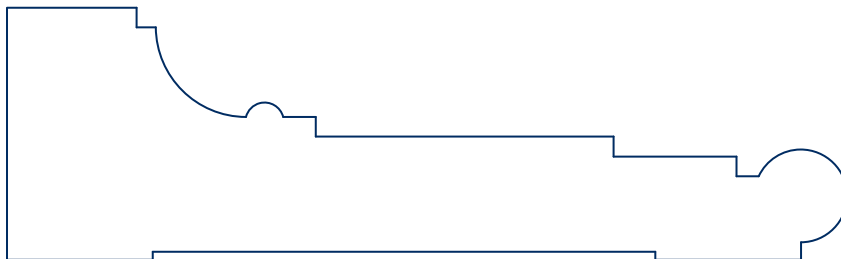

IL 298  
1 5/16 x 4 3/8

Profiles Shown 1:1

Greenwich, CT  
203.531.8050 914.939.2500

Bethel, CT  
203.748.5629

Newtown, CT  
203.364.0074

Stamford, CT  
203.348.3761

Westport, CT  
203.226.3321

Shrub Oak, NY  
914.245.5050



4"

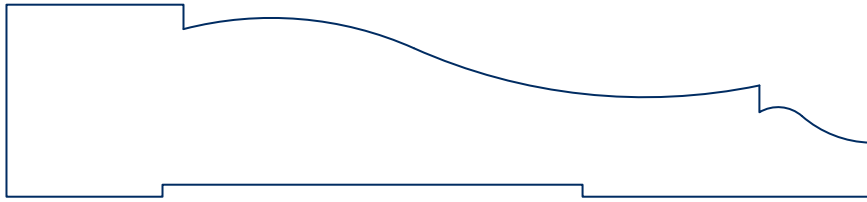

IL 218  
1 x 4 1/2

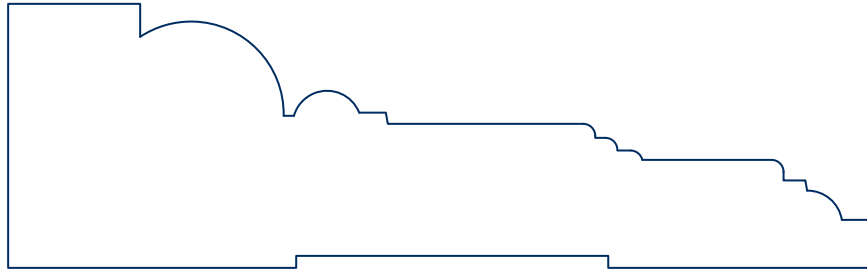

IL 219  
1 3/8 x 4 1/2  p.32

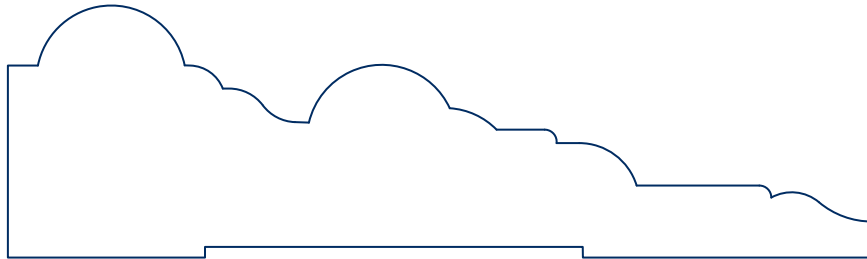

IL 212  
1 5/16 x 4 1/2

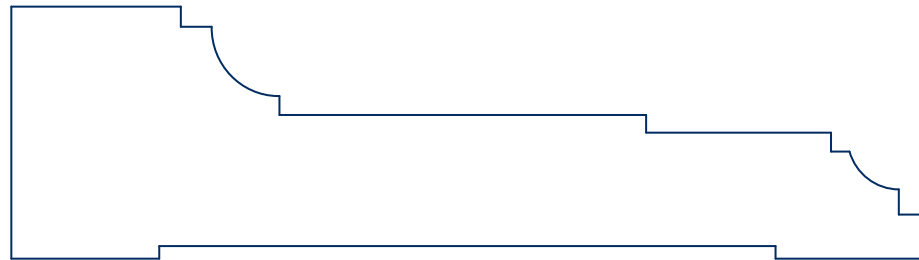

IL 299  
1 5/16 x 4 3/4

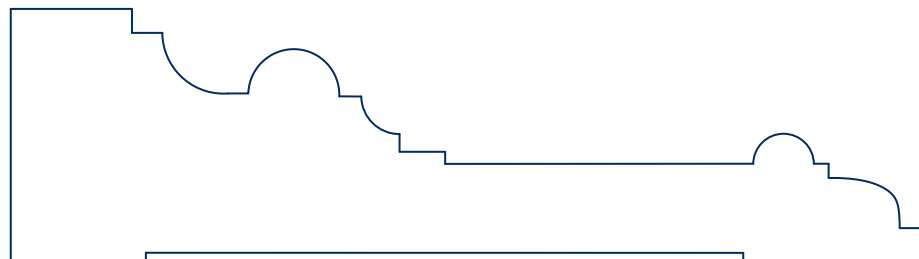

IL 2000  
1 5/16 x 4 3/4



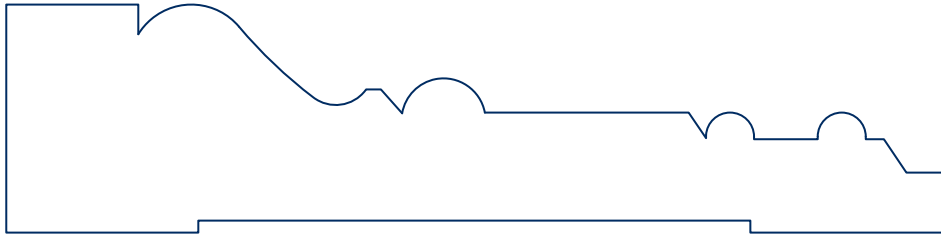

IL 220  
1 3/16 x 4 7/8

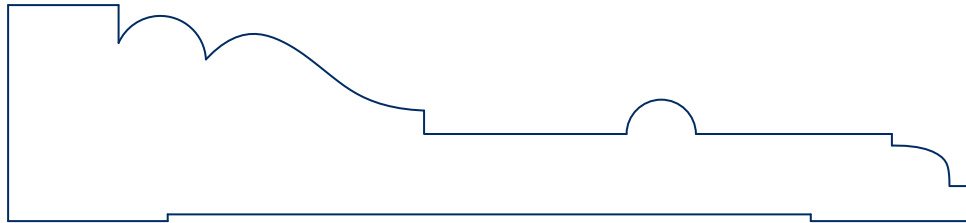

IL 2001  
1 1/8 x 5

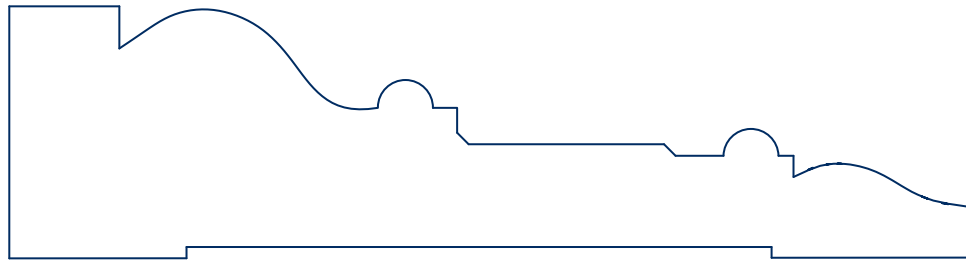

IL 2002  
1 5/16 x 5

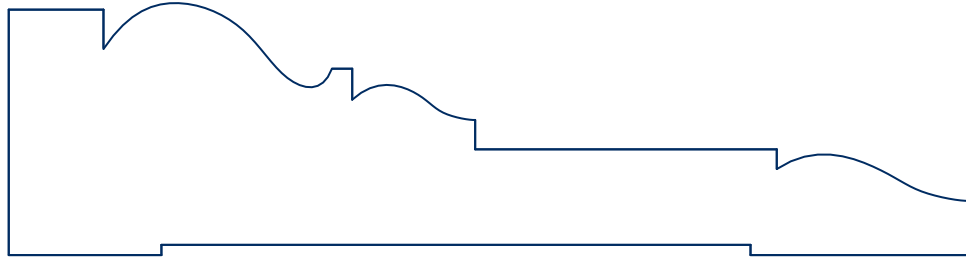

IL 2003  
1 5/16 x 5

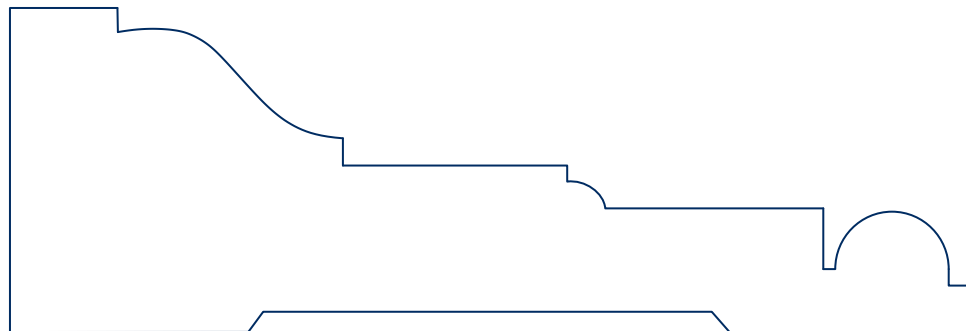

IL 2004  
1 11/16 x 5

Profiles Shown 1:1

Greenwich, CT  
203.531.8050 914.939.2500

Bethel, CT  
203.748.5629

Newtown, CT  
203.364.0074

Stamford, CT  
203.348.3761

Westport, CT  
203.226.3321

Shrub Oak, NY  
914.245.5050



5"

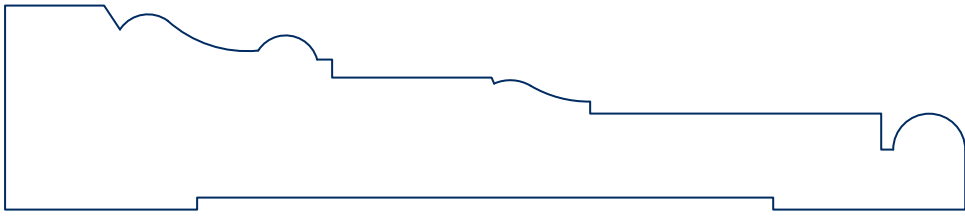

IL 228  
1 1/16 x 5

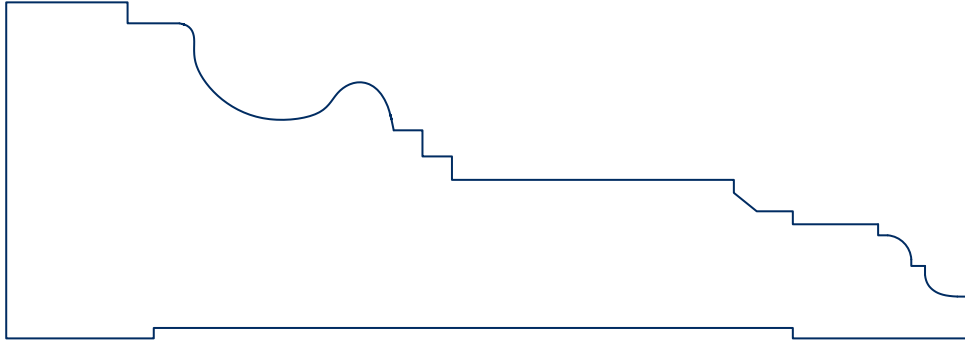

IL 2005  
1 3/4 x 5



IL 287  
3/4 x 5 1/2

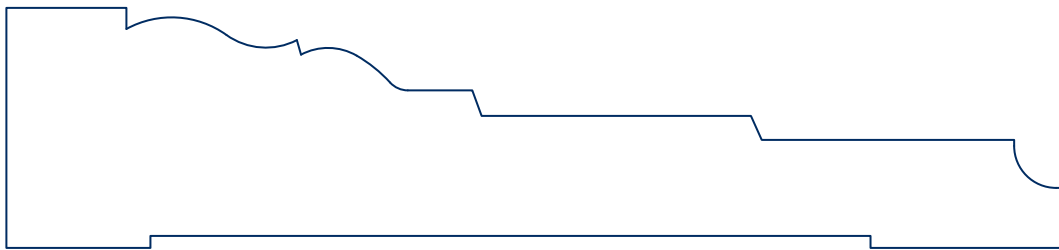

IL 221  
1 1/4 x 5 1/2

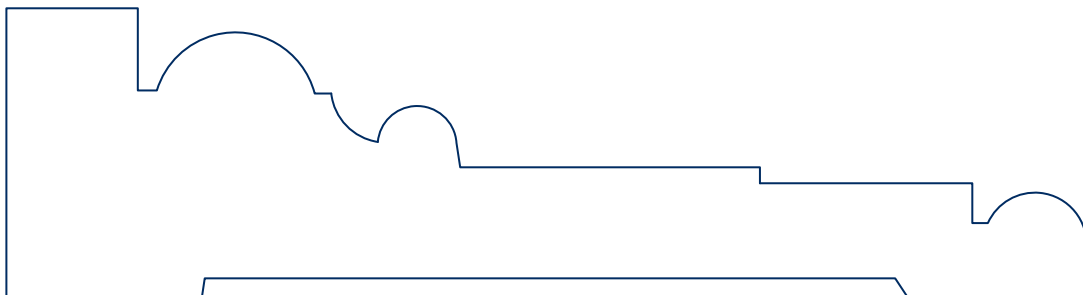

IL 282  
1 1/2 x 5 5/8



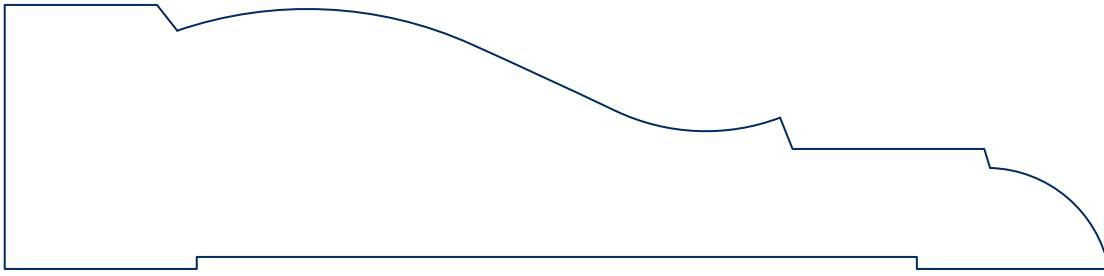

IL 251  
1 3/8 x 5 3/4

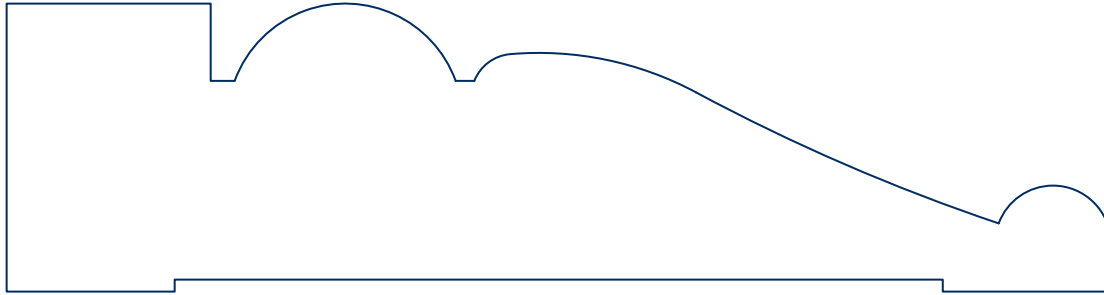

IL 260  
1 1/2 x 5 3/4

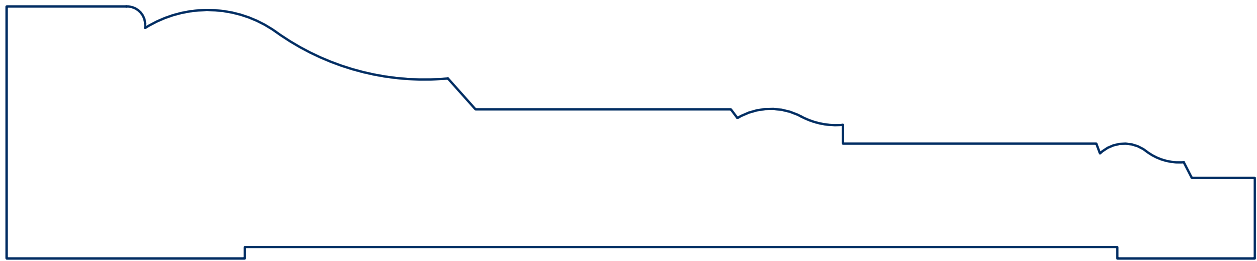

IL 222  
1 5/16 x 6 1/2

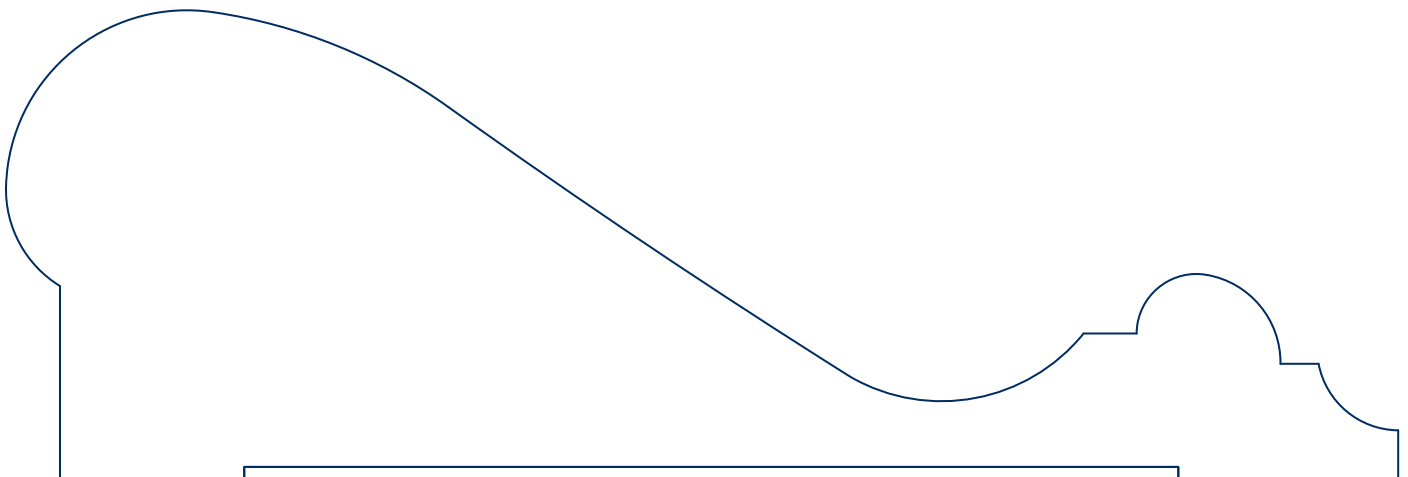

IL 252  
2 7/16 x 7 1/4

Profiles Shown 1:1

Greenwich, CT  
203.531.8050 914.939.2500

Bethel, CT  
203.748.5629

Newtown, CT  
203.364.0074

Stamford, CT  
203.348.3761

Westport, CT  
203.226.3321

Shrub Oak, NY  
914.245.5050





3" - 4"

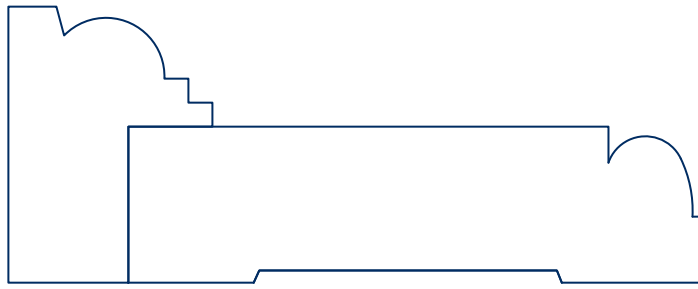

IL 233B      IL 233      Overall Dimension = 3 5/8  
 1 7/16 x 1 1/16      13/16 x 3

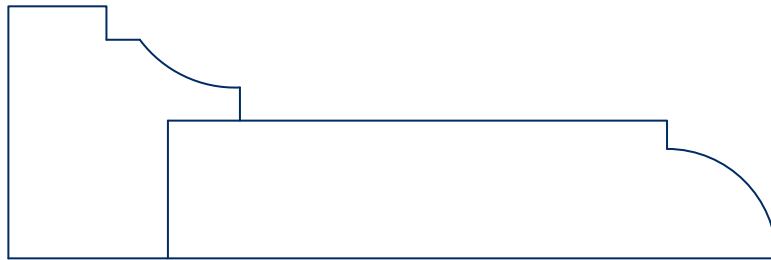

IL 2006B      IL 2006      Overall Dimension = 4  
 1 5/16 x 1 3/16      11/16 x 3 3/16

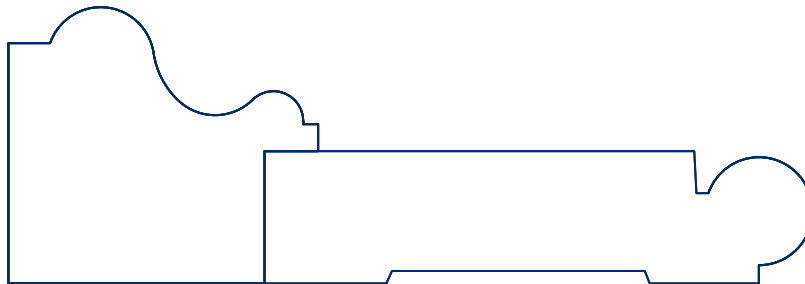

IL 226B      IL 226      Overall Dimension = 4 3/16  
 1 7/16 x 1 5/8      11/16 x 2 7/8

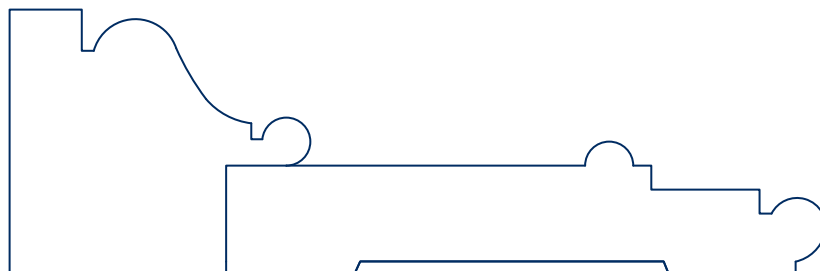

IL 230B      IL 230      Overall Dimension = 4 1/4  
 1 3/8 x 1 9/16      11/16 x 3 1/8

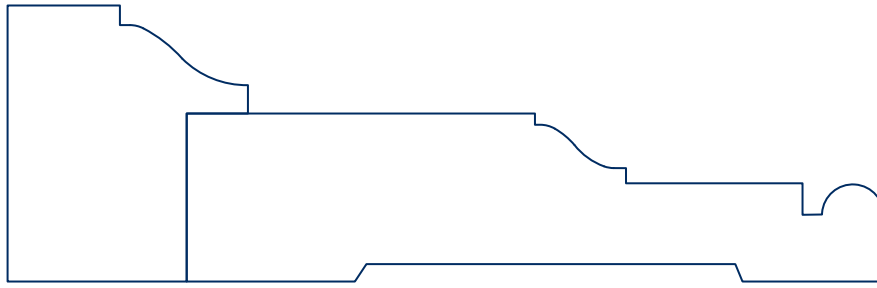

**IL 285B**  
1 7/16 x 1 1/4

**IL 285**  
7/8 x 3 5/8

Overall Dimension = 4 9/16

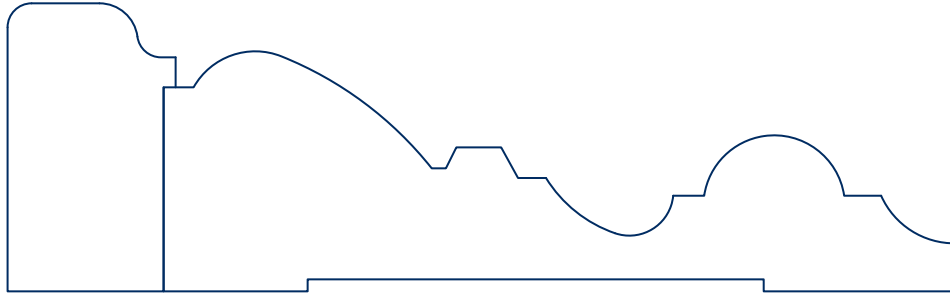

**IL 206B**  
1 1/2 x 7/8

**IL 206**  
1 1/4 x 4 1/8

Overall Dimension = 4 15/16

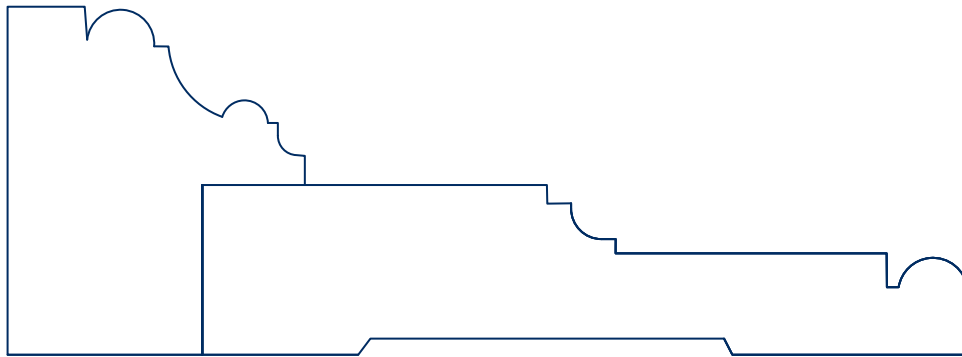

**IL 284B**  
1 13/16 x 1 9/16

**IL 284**  
7/8 x 4

Overall Dimension = 5

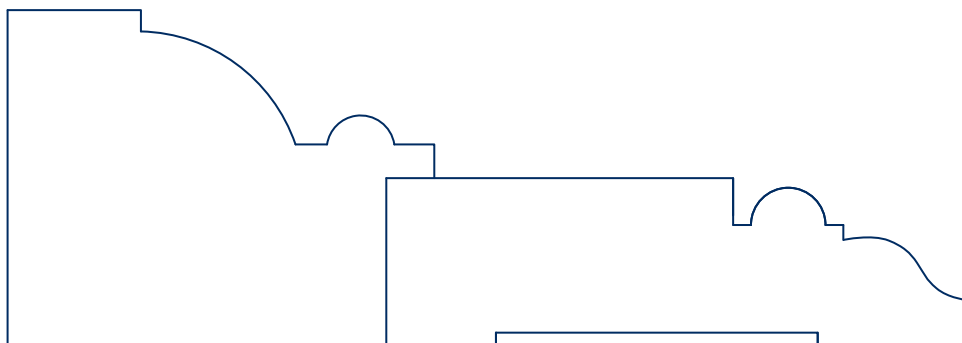

**IL 2008B**  
1 3/4 x 2 1/4

**IL 2008**  
7/8 x 3

Overall Dimension = 5

Profiles Shown 1:1

Greenwich, CT  
203.531.8050 914.939.2500

Bethel, CT  
203.748.5629

Newtown, CT  
203.364.0074

Stamford, CT  
203.348.3761

Westport, CT  
203.226.3321

Shrub Oak, NY  
914.245.5050



5"

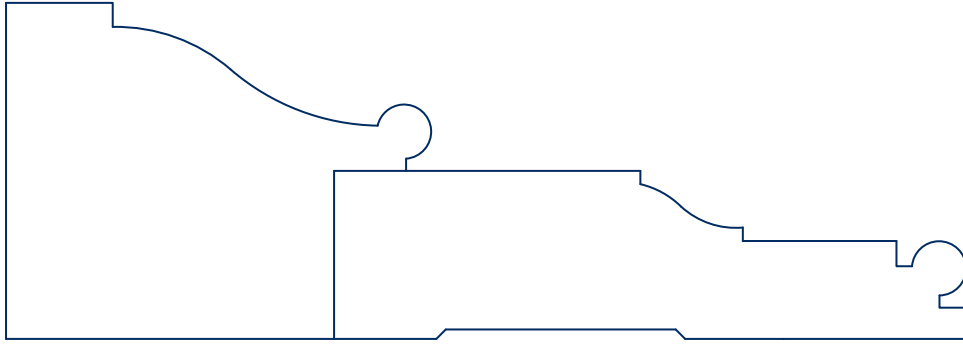

**IL 2009B**  
1 3/4 x 2 3/16

**IL 2009**  
7/8 x 3 5/16

*Overall Dimension = 5*

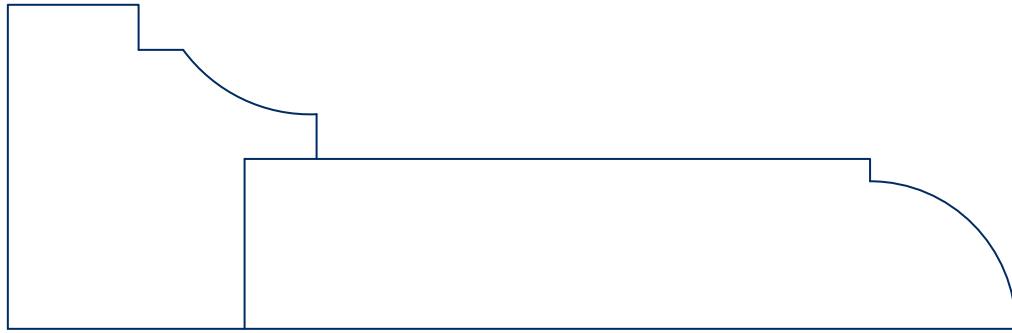

**IL 2007B**  
1 11/16 x 1 5/8

**IL 2007**  p.32  
7/8 x 4

*Overall Dimension = 5 1/4*

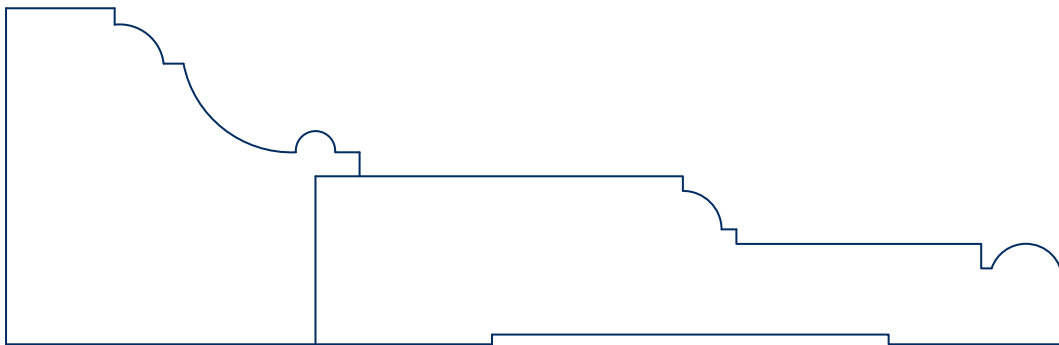

**IL 2010B**  
1 3/4 x 1 13/16

**IL 2010**  
7/8 x 3 7/8

*Overall Dimension = 5 1/2*

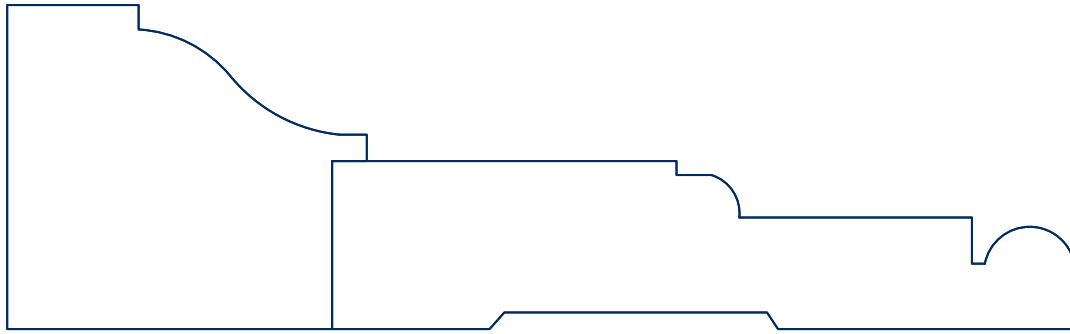

**IL 283B**  
1 11/16 x 1 7/8

**IL 283**  
7/8 x 3 7/8

Overall Dimension = 5 9/16

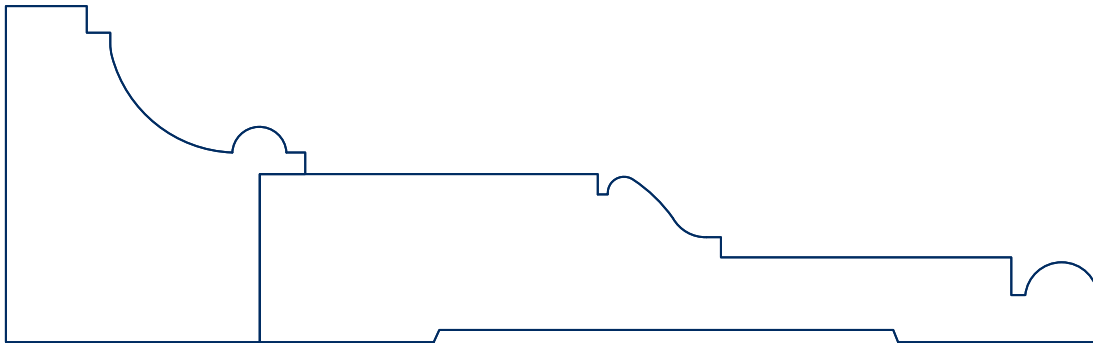

**IL 286B**  
1 3/4 x 1 9/16

**IL 286**  
7/8 x 4 3/8

Overall Dimension = 5 11/16

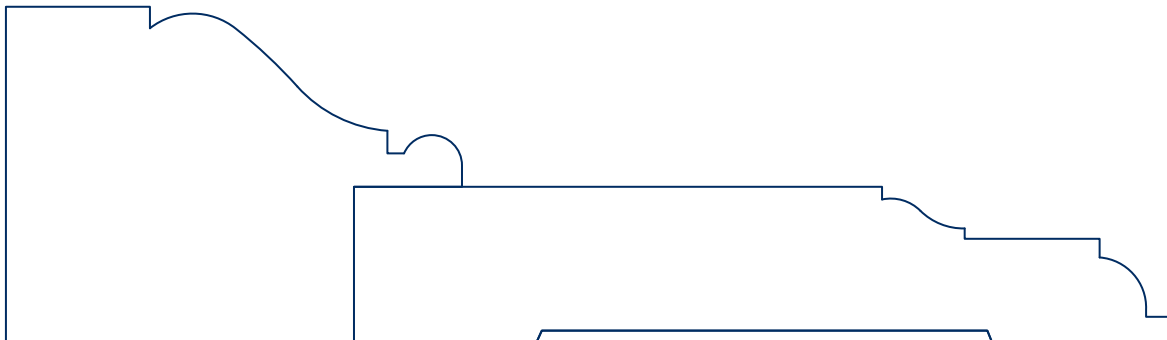

**IL 259B**  
1 3/4 x 2 3/8

**IL 259**  
13/16 x 4 1/4

Overall Dimension = 6 1/16



**IL 229B**  
1 5/8 x 2

**IL 229**  
3/4 x 4 1/2

Overall Dimension = 6 3/16

Profiles Shown 1:1

**Greenwich, CT**  
203.531.8050 914.939.2500

**Bethel, CT**  
203.748.5629

**Newtown, CT**  
203.364.0074

**Stamford, CT**  
203.348.3761

**Westport, CT**  
203.226.3321

**Shrub Oak, NY**  
914.245.5050





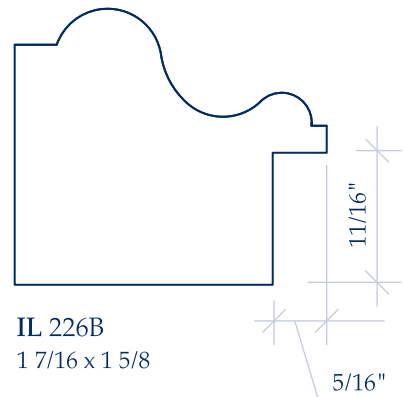
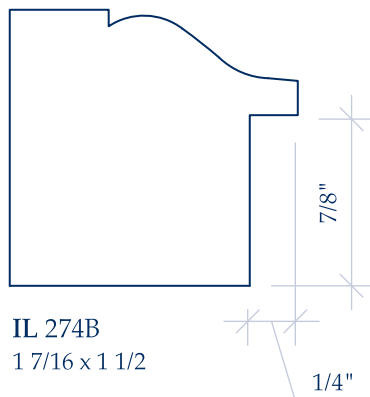
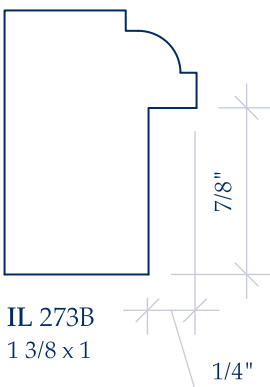
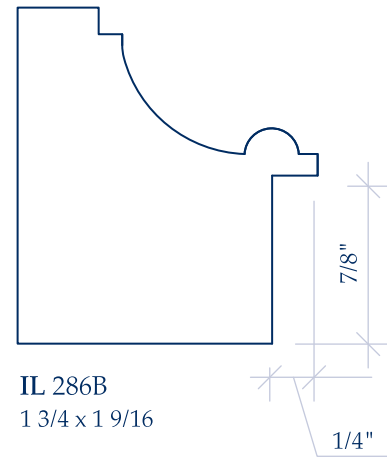
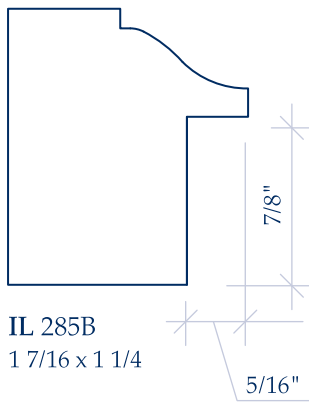
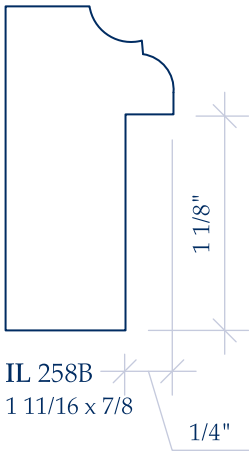
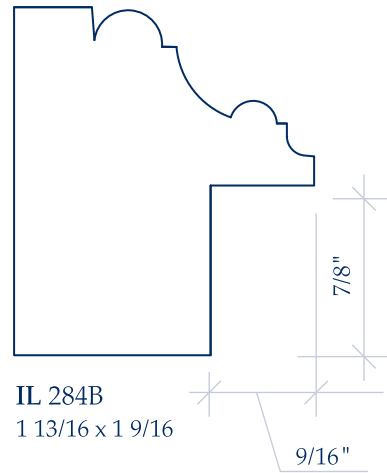
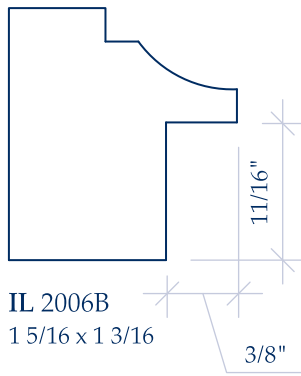
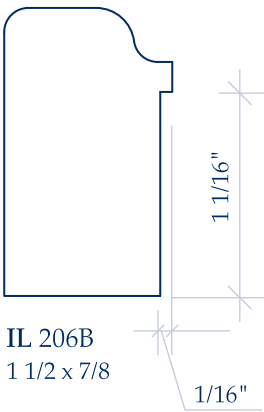
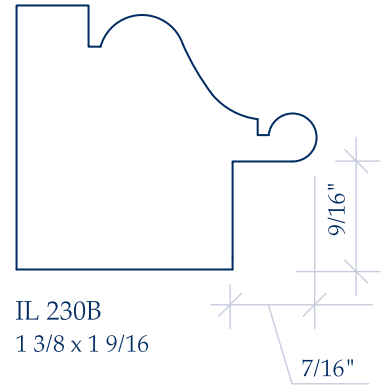
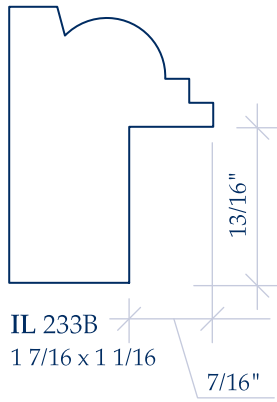
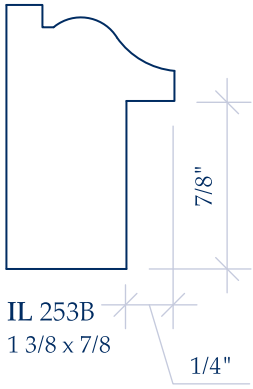

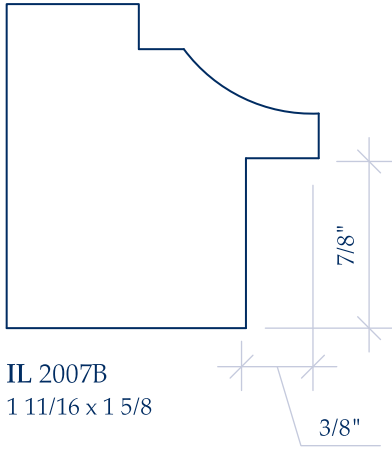

**IL 2007B**  
1 11/16 x 1 5/8

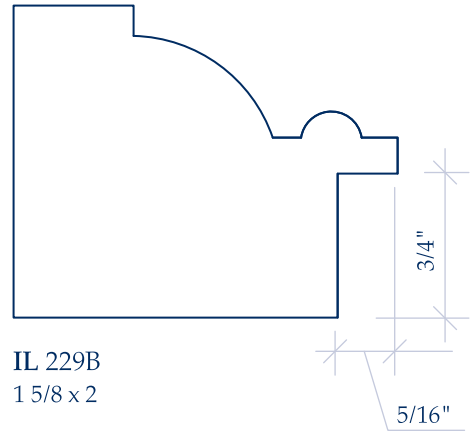

**IL 229B**  
1 5/8 x 2

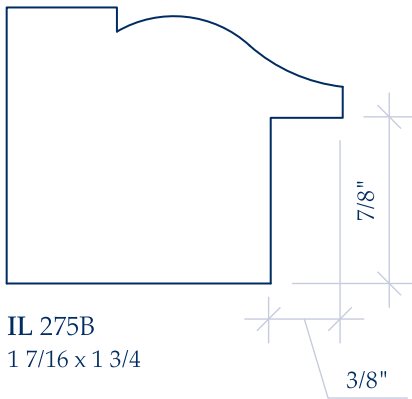

**IL 275B**  
1 7/16 x 1 3/4

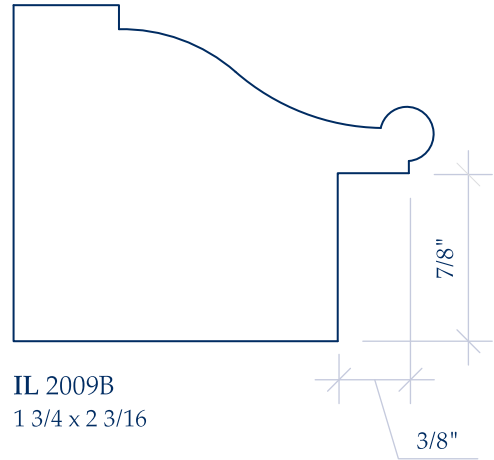

**IL 2009B**  
1 3/4 x 2 3/16

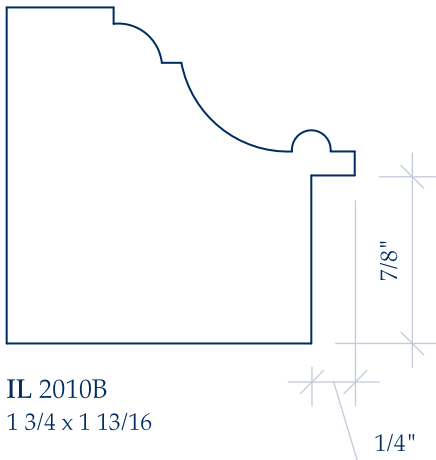

**IL 2010B**  
1 3/4 x 1 13/16

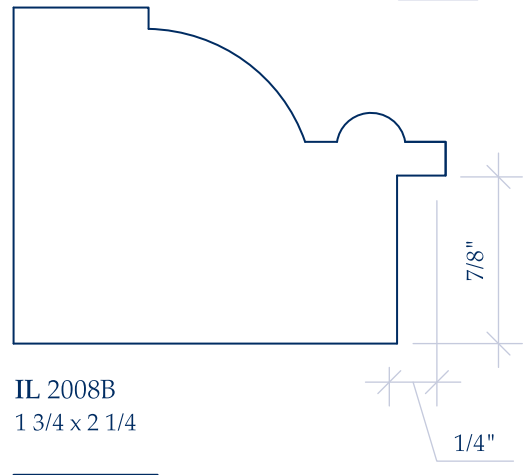

**IL 2008B**  
1 3/4 x 2 1/4

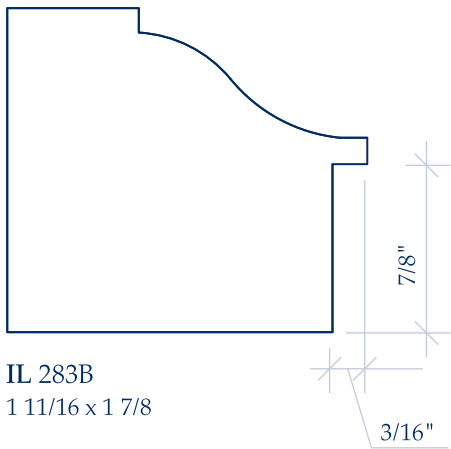

**IL 283B**  
1 11/16 x 1 7/8

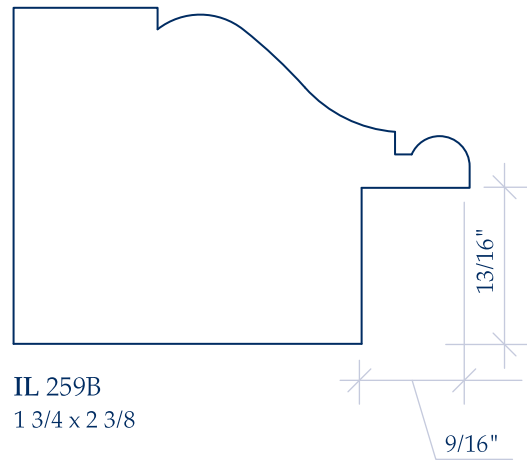

**IL 259B**  
1 3/4 x 2 3/8

Profiles Shown 1:1

**Greenwich, CT**  
203.531.8050 914.939.2500

**Bethel, CT**  
203.748.5629

**Newtown, CT**  
203.364.0074

**Stamford, CT**  
203.348.3761

**Westport, CT**  
203.226.3321

**Shrub Oak, NY**  
914.245.5050





**IL 269B**  
5/8 x 3/4



**IL 277**  
3/4 x 2 3/4



**IL 265B**  
3/4 x 3/4

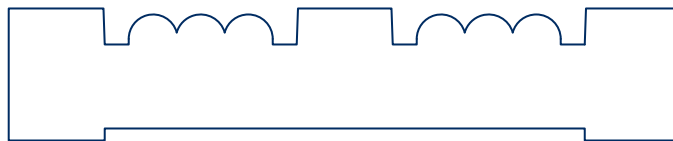

**IL 280**  
11/16 x 3 1/2

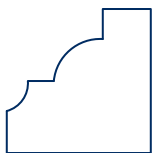

**IL 264B**  
3/4 x 3/4



**IL 276**  
3/4 x 3 5/8



**IL 261B**  
5/8 x 11/16

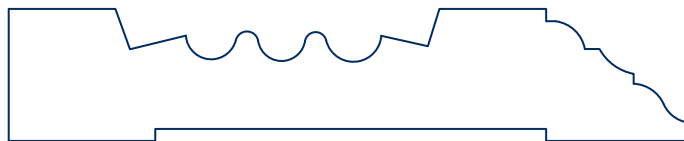

**IL 261**  
11/16 x 3 9/16



**IL 268B**  
11/16 x 13/16

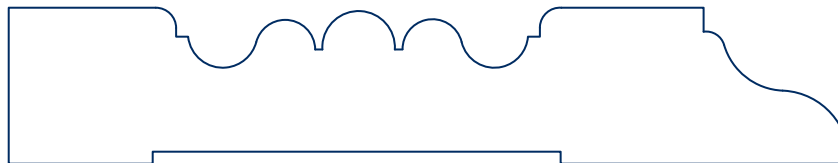

**IL 268**  
13/16 x 4 3/8

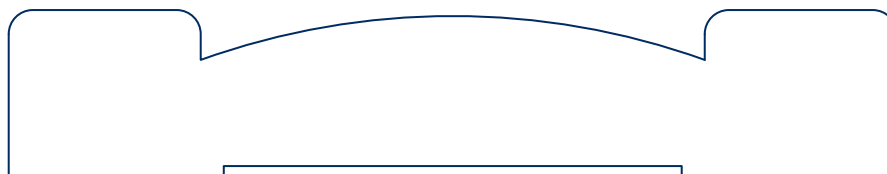

**IL 263**  
7/8 x 4 5/8

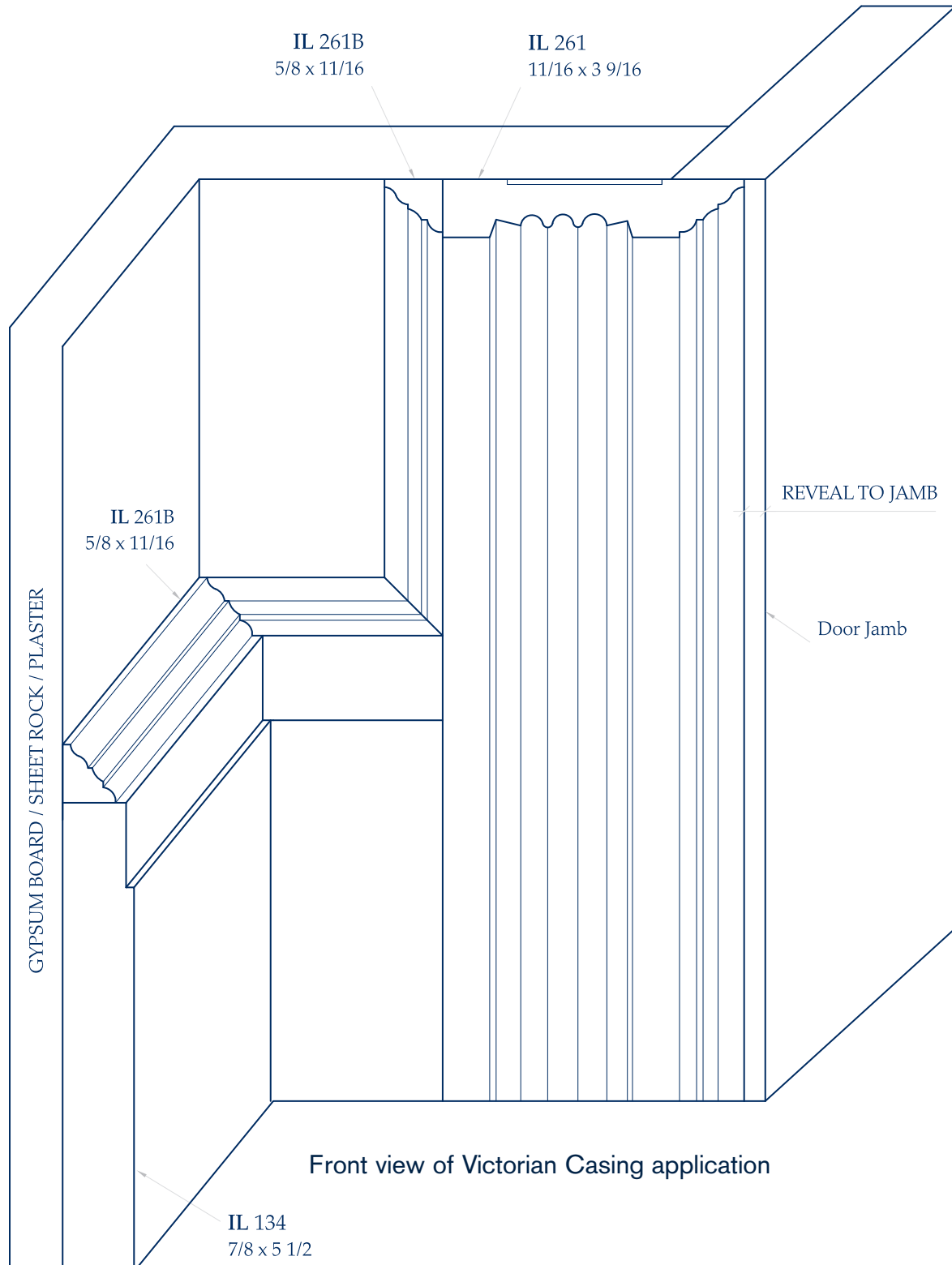

Profiles Shown 1:1

Greenwich, CT  
203.531.8050 914.939.2500

Bethel, CT  
203.748.5629

Newtown, CT  
203.364.0074

Stamford, CT  
203.348.3761

Westport, CT  
203.226.3321

Shrub Oak, NY  
914.245.5050





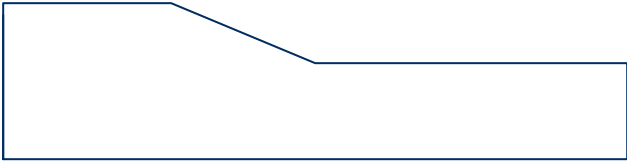

IL 207PB  
13/16 x 3 1/4

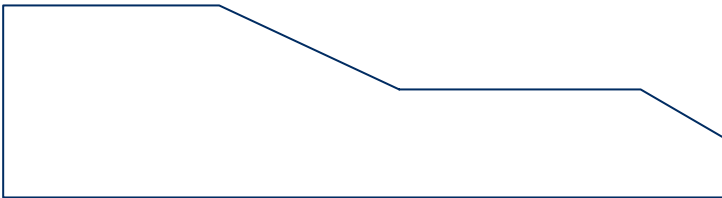

IL 2XXPB  
1 x 3 3/4

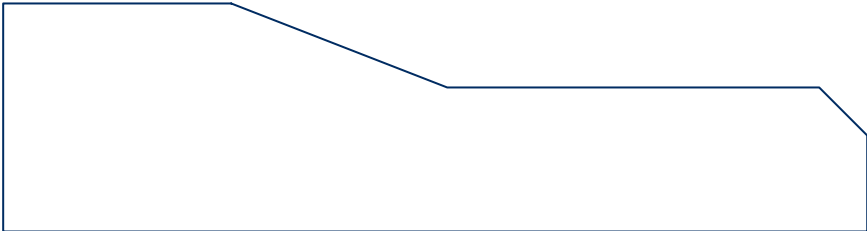

IL 224PB  
1 3/16 x 4 1/2

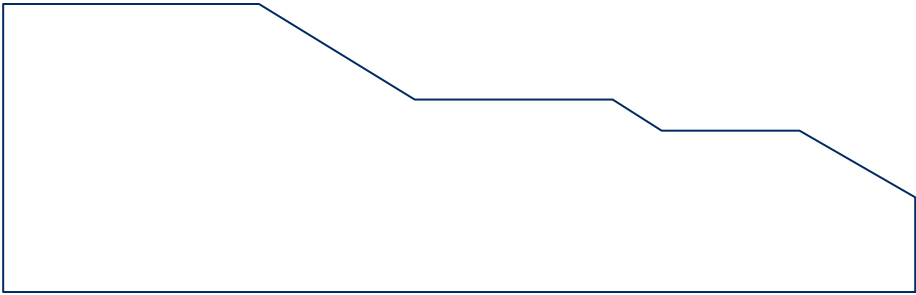

IL 219PB  
1 1/2 x 4 3/4





IL QUIRK 1  
1/2 x 1/2



IL QUIRK 2  
3/4 x 3/4

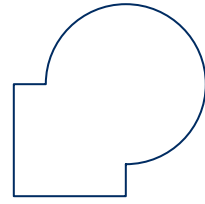

IL QUIRK 3  
1 x 1

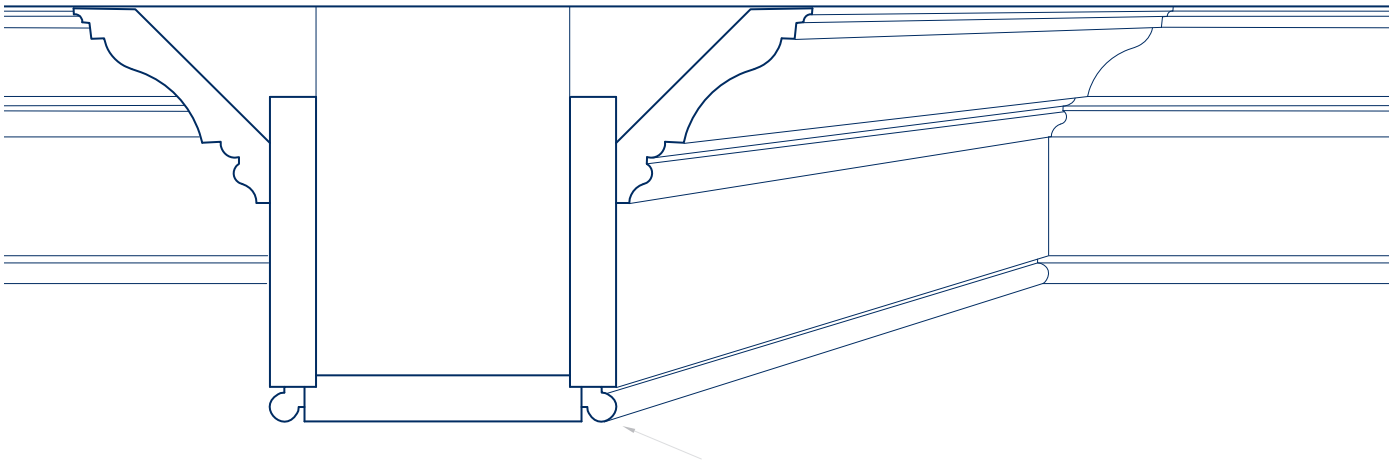

A Quirk Moulding is a decorative strip that may be used to finish a seam where two boards meet, creating a bead detail, as in the coffered ceiling example shown above.

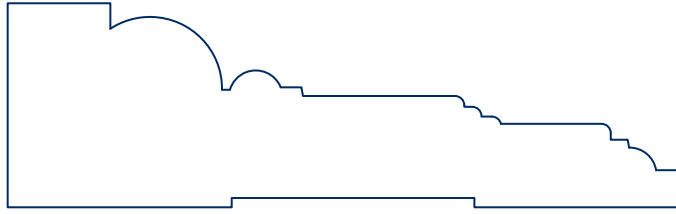

**IL 289**  
1 1/16 x 3 1/2

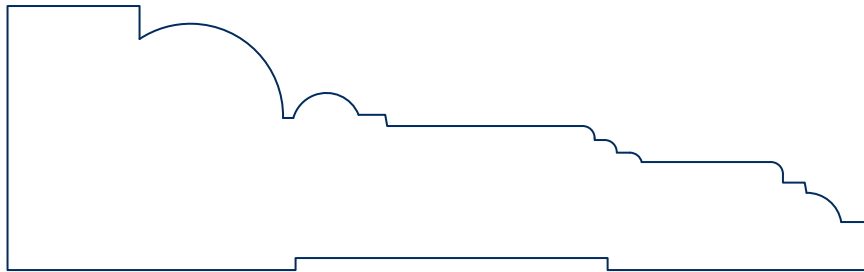

**IL 219**  
1 3/8 x 4 1/2



**IL 2006B**  
1 5/16 x 1 3/16

**IL 2006**  
1 1/16 x 3 3/16

*Overall Dimension = 4*

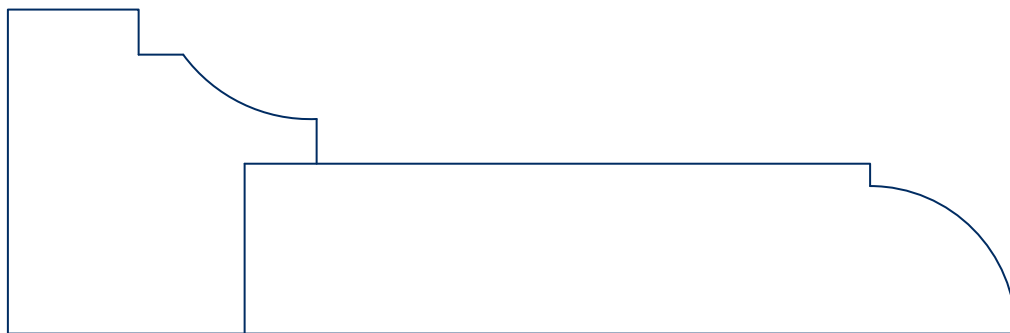

**IL 2007B**  
1 11/16 x 1 5/8

**IL 2007**  
7/8 x 4

*Overall Dimension = 5 1/4*



2" - 5"

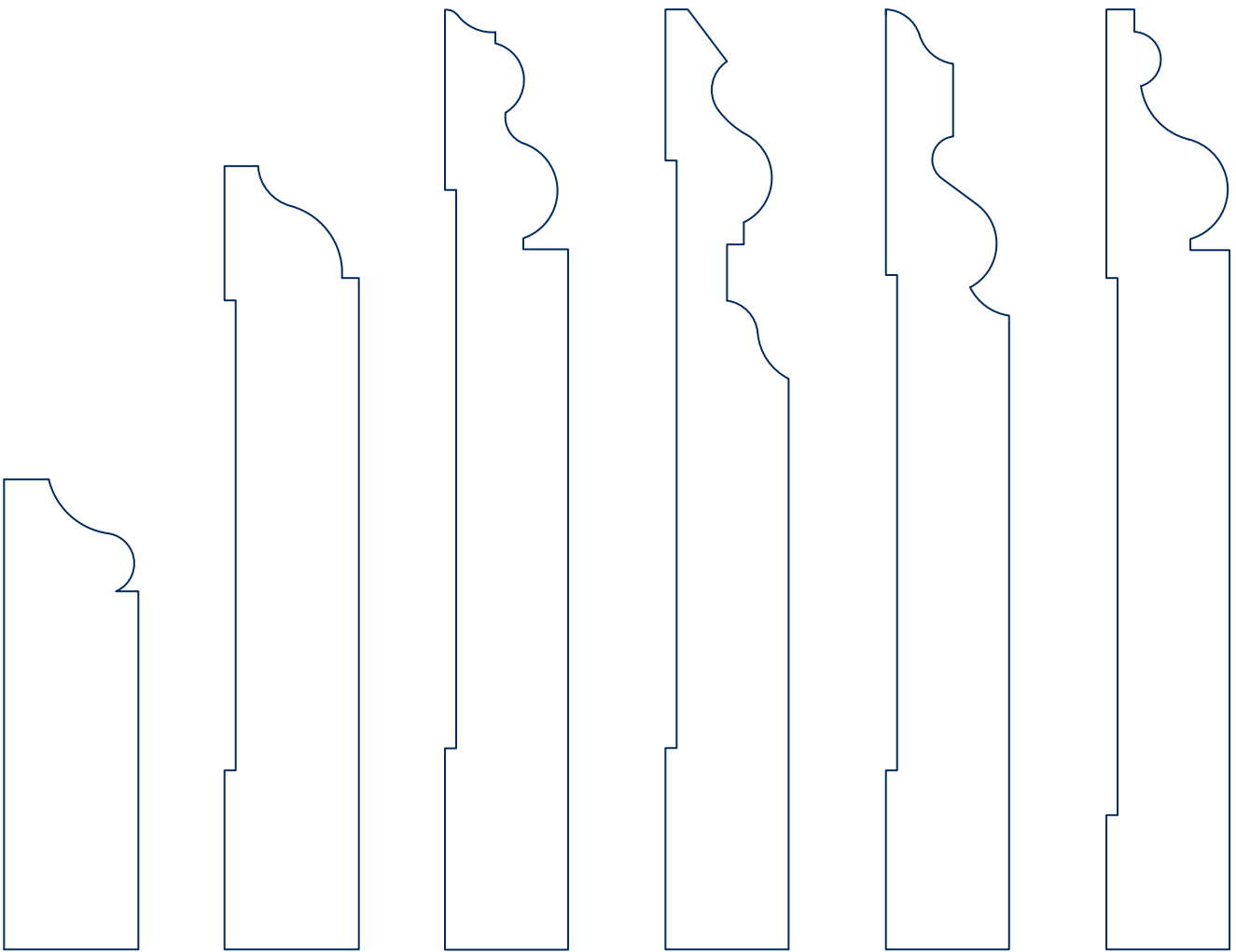

**IL 123**  
3/4 x 2 5/8

**IL 122**  
3/4 x 4 3/8

**IL 107**  
11/16 x 5 1/4

**IL 121**  
11/16 x 5 1/4

**IL 120**  
11/16 x 5 1/4

**IL 119**  
11/16 x 5 1/4







IL 104  
1 1/16 x 5 1/4



IL 101  
1 1/16 x 5 1/4



IL 127  
1 1/16 x 5 1/2



IL 118  
1 1/16 x 5 3/4

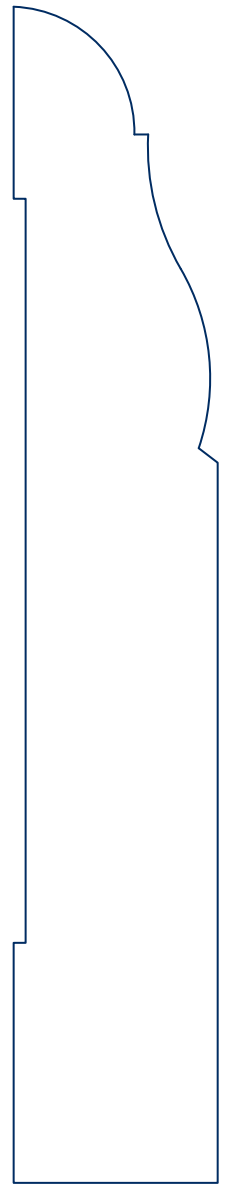

IL 112  
1 1/16 x 6 1/8

Profiles Shown 1:1

Greenwich, CT  
203.531.8050 914.939.2500

Bethel, CT  
203.748.5629

Newtown, CT  
203.364.0074

Stamford, CT  
203.348.3761

Westport, CT  
203.226.3321

Shrub Oak, NY  
914.245.5050



7"



IL 1197  
1 1/16 x 7



IL 1077  
1 1/16 x 7



IL 1047  
1 1/16 x 7



IL 117  
1 1/16 x 7

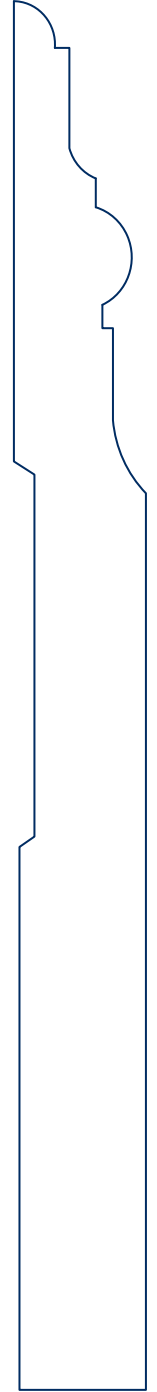

IL 1277  
1 1/16 x 7 1/4



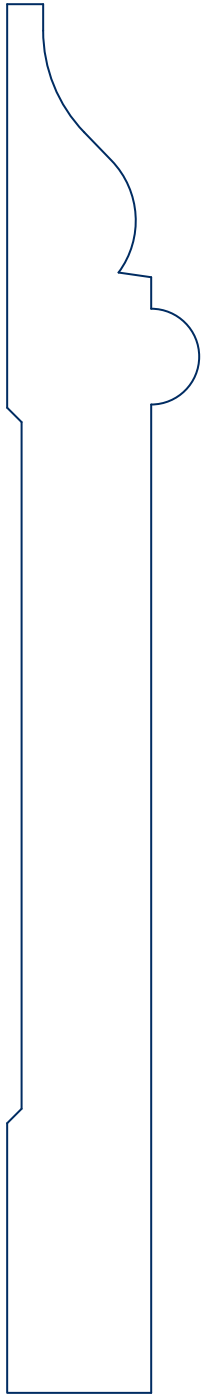

IL 133  
1 x 7 1/4

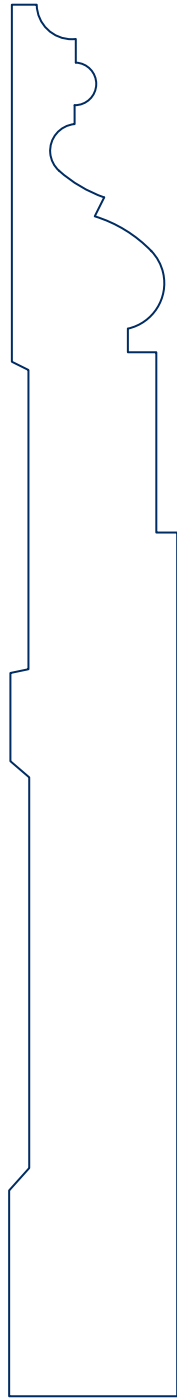

IL 126  
7/8 x 7 1/4



IL 124  
1 x 7 1/4



IL 111  
1 1/16 x 7 5/8

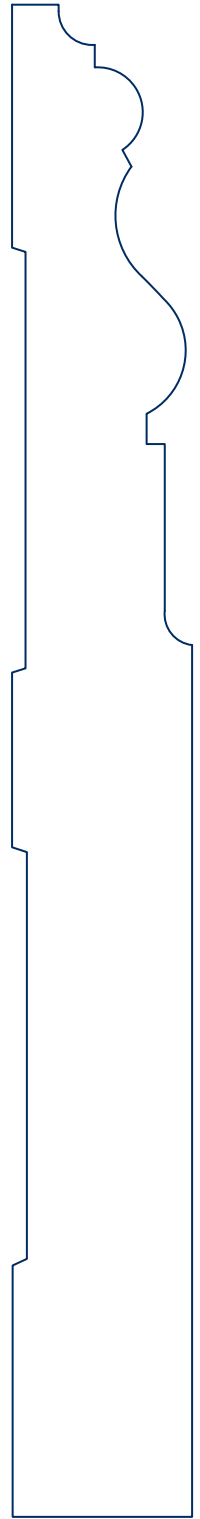

IL 125  
15/16 x 7 7/8

Profiles Shown 1:1

Greenwich, CT  
203.531.8050 914.939.2500

Bethel, CT  
203.748.5629

Newtown, CT  
203.364.0074

Stamford, CT  
203.348.3761

Westport, CT  
203.226.3321

Shrub Oak, NY  
914.245.5050



4" - 5"

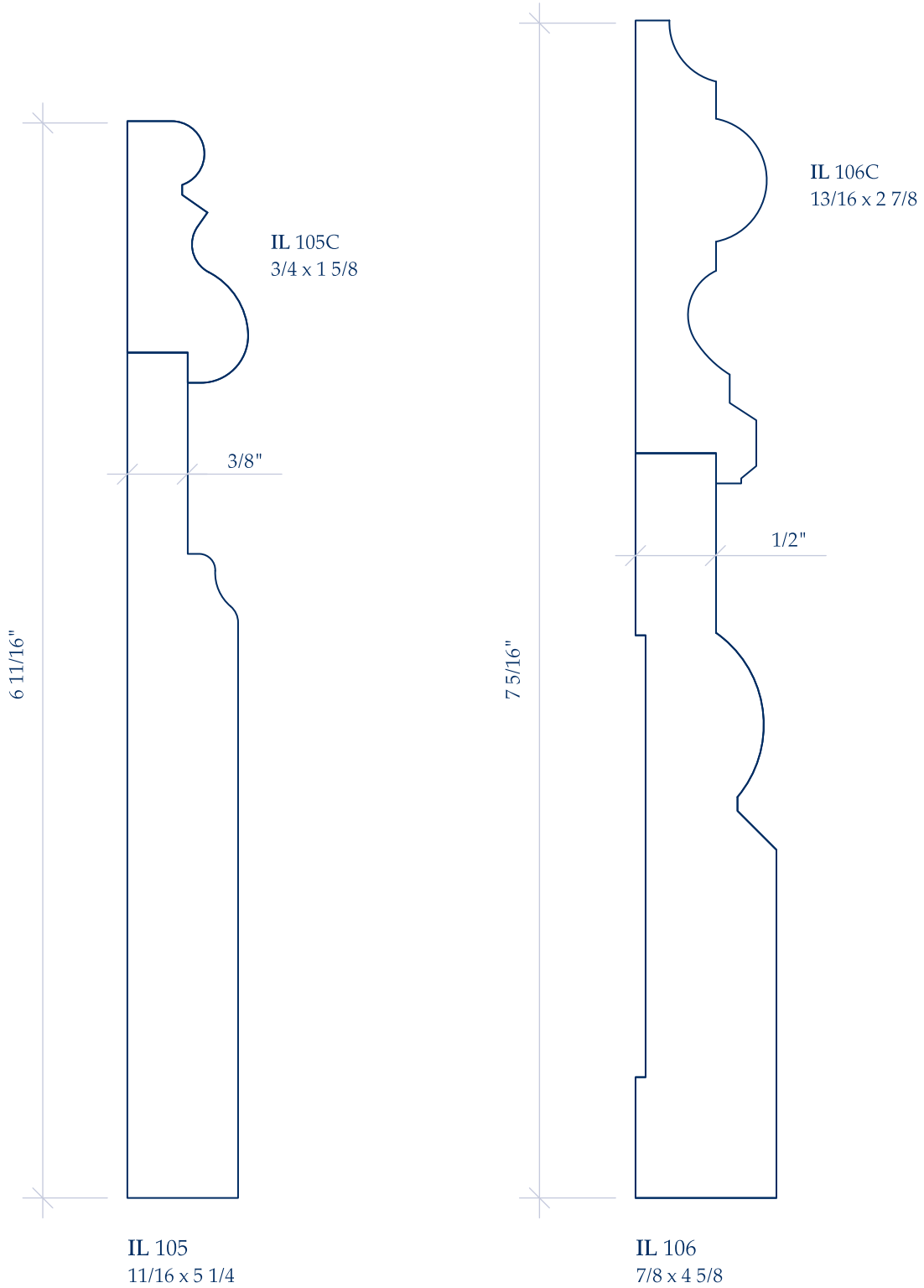

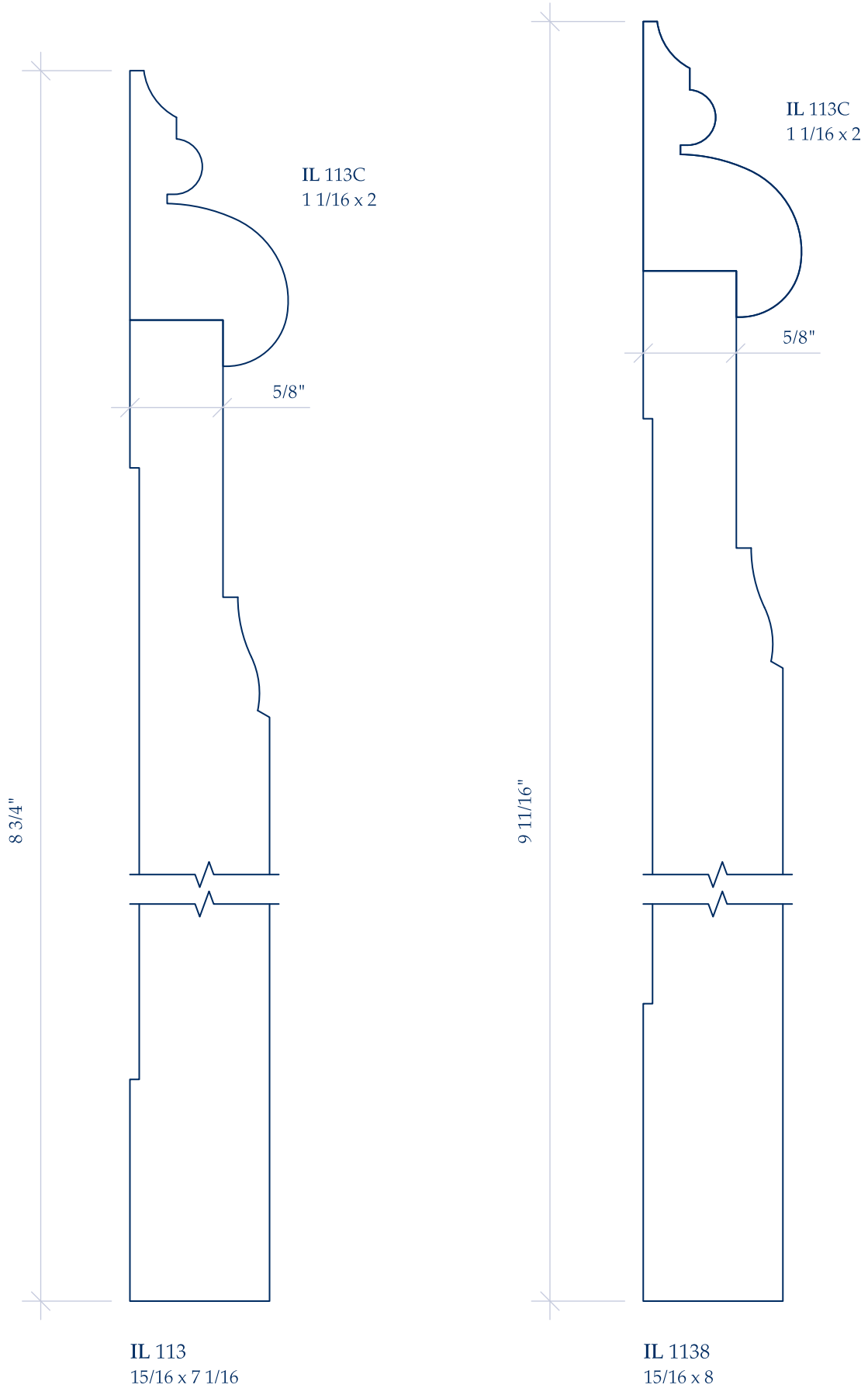

Profiles Shown 1:1

Greenwich, CT  
203.531.8050 914.939.2500

Bethel, CT  
203.748.5629

Newtown, CT  
203.364.0074

Stamford, CT  
203.348.3761

Westport, CT  
203.226.3321

Shrub Oak, NY  
914.245.5050





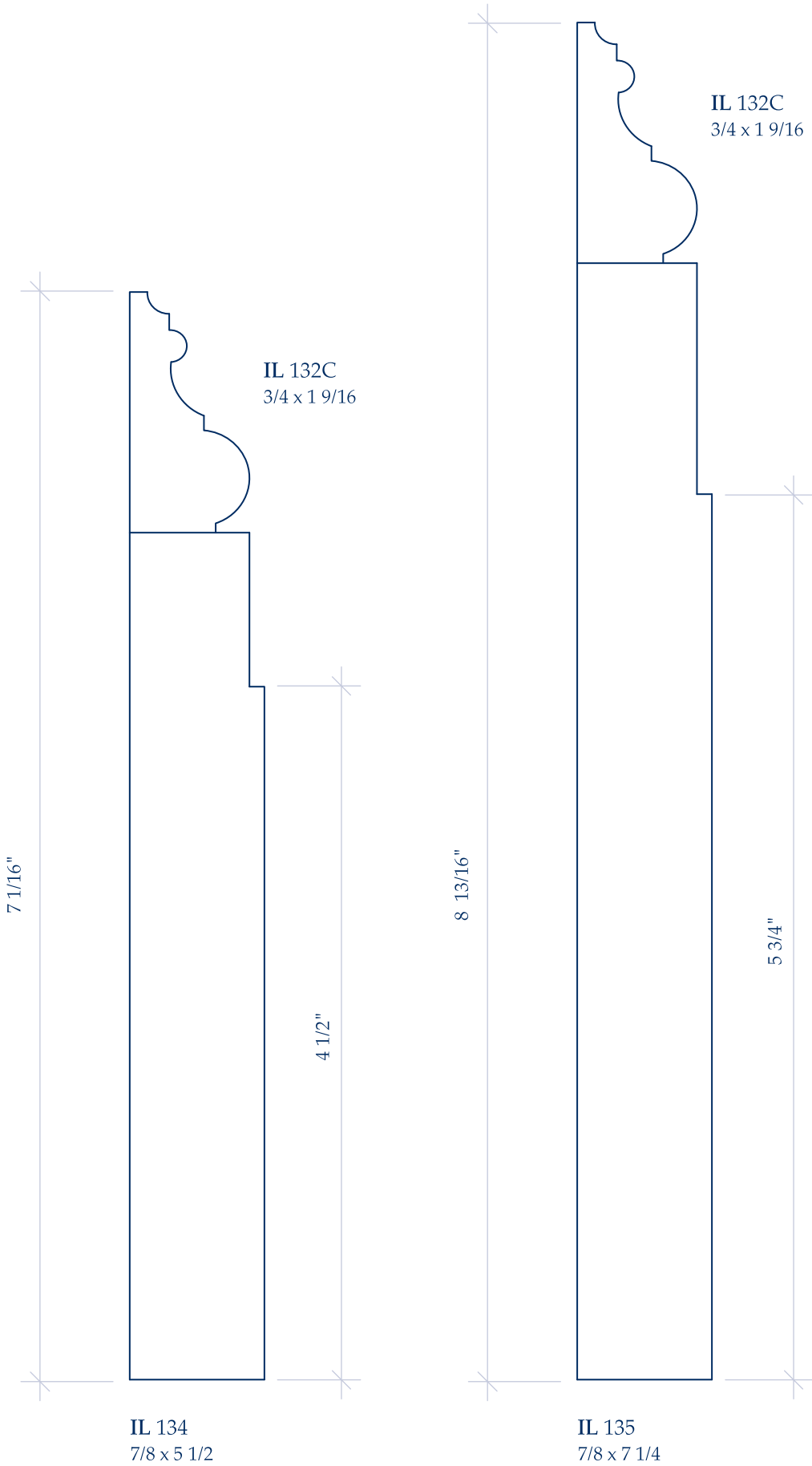



**IL 123C**  
11/16 x 1

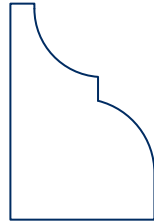

**IL 110C**  
3/4 x 1 1/8



**IL 120C**  
11/16 x 1 1/4



**IL 132C**  
3/4 x 1 9/16

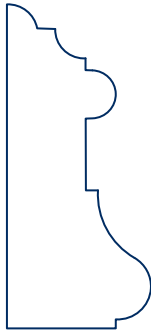

**IL 117C**  
3/4 x 1 11/16



**IL 103C**  
11/16 x 1 5/8

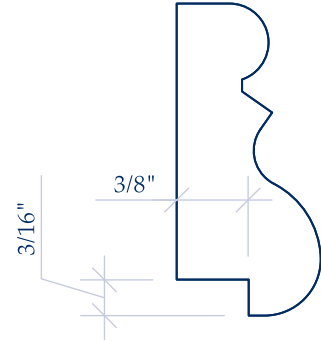

**IL 105C**  
3/4 x 1 5/8



**IL 118C**  
3/4 x 1 3/4



**IL 129C**  
3/4 x 1 3/4



**IL 127C**  
3/4 x 1 13/16

Profiles Shown 1:1

Greenwich, CT  
203.531.8050 914.939.2500

Bethel, CT  
203.748.5629

Newtown, CT  
203.364.0074

Stamford, CT  
203.348.3761

Westport, CT  
203.226.3321

Shrub Oak, NY  
914.245.5050



1" - 2"



IL 128C  
3/4 x 1 7/8



IL 131C  
3/4 x 2

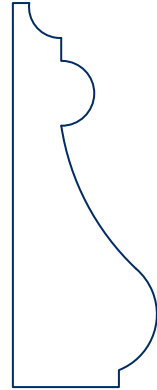

IL 130C  
3/4 x 2

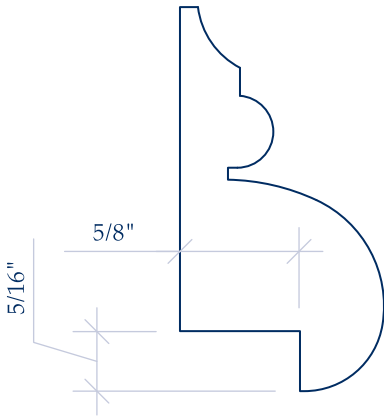

IL 113C  
1 1/16 x 2

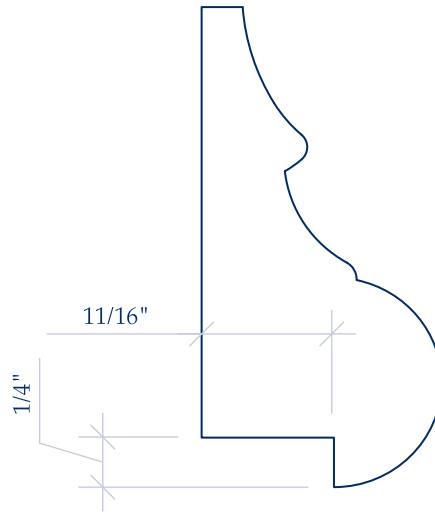

IL 125C  
1 1/4 x 2 1/2

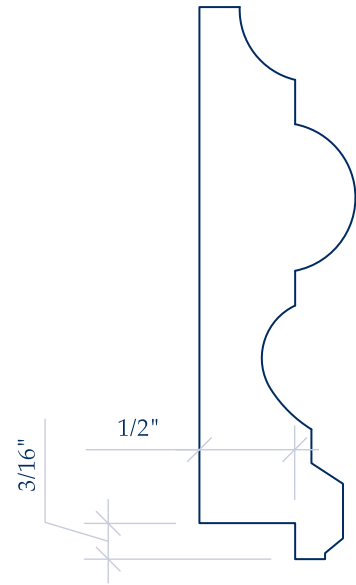

IL 106C  
13/16 x 2 7/8



**IL 102S**  
1/2 x 3/4



**IL 101S**  
3/8 x 13/16



**IL 104S**  
1/2 x 1 1/16



**IL 136S**  
1/2 x 1 1/16



**IL 137S**  
1/2 x 1 1/8



**IL 105S**  
1/2 x 1 1/8



**IL 103S**  
1/2 x 1 1/4



**IL 138S**  
1/2 x 1 3/4

Profiles Shown 1:1

**Greenwich, CT**  
203.531.8050 914.939.2500

**Bethel, CT**  
203.748.5629

**Newtown, CT**  
203.364.0074

**Stamford, CT**  
203.348.3761

**Westport, CT**  
203.226.3321

**Shrub Oak, NY**  
914.245.5050



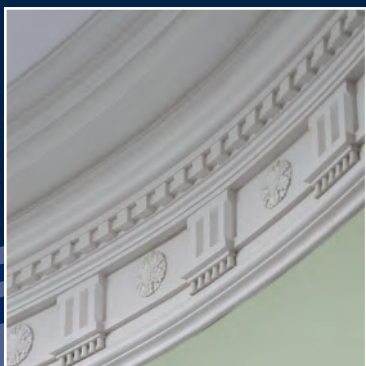
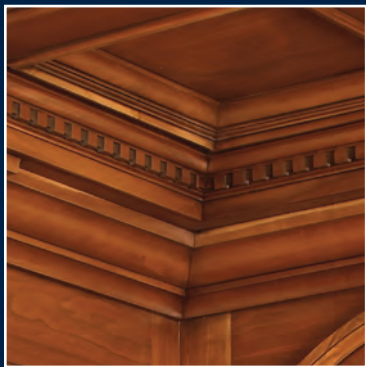





2" - 3"

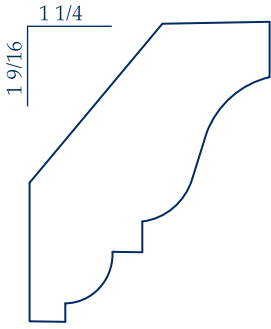

**IL 310**  
11/16 x 2

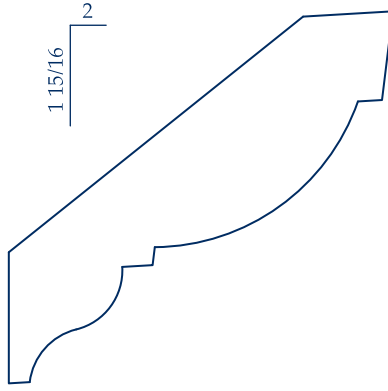

**IL 329**  
11/16 x 2 3/4

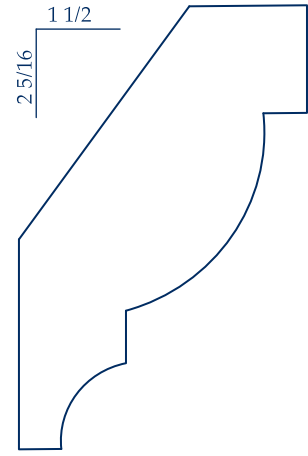

**IL 322**  
7/8 x 2 3/4

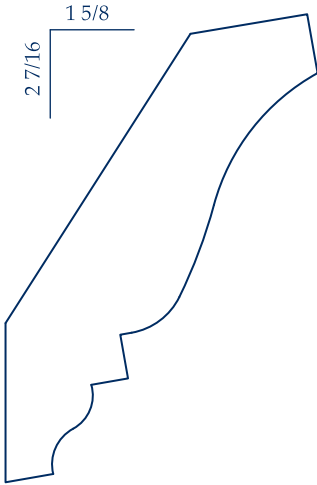

**IL 313**  
11/16 x 2 7/8

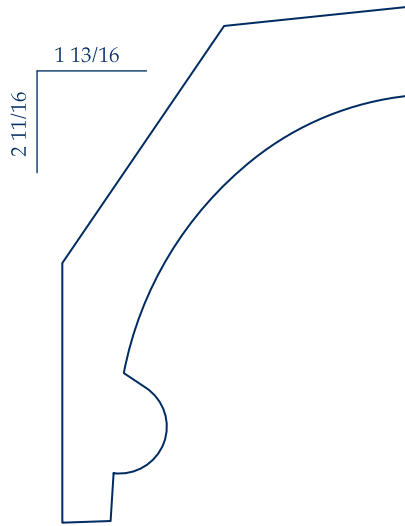

**IL 353**  
1 x 3 1/4

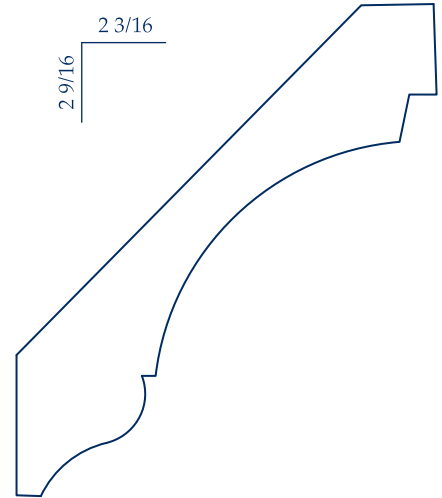

**IL 350**  
11/16 x 3 5/16

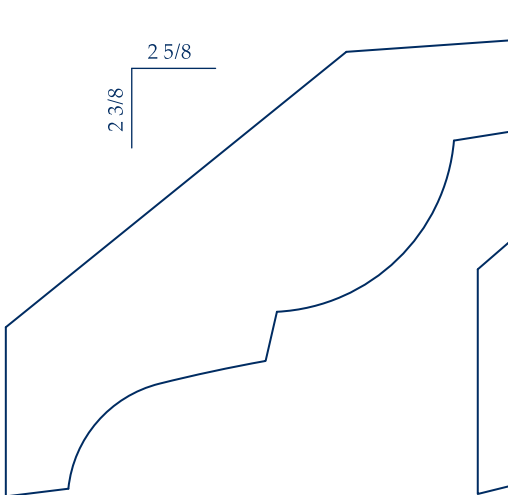

**IL 324**  
1 x 3 1/2

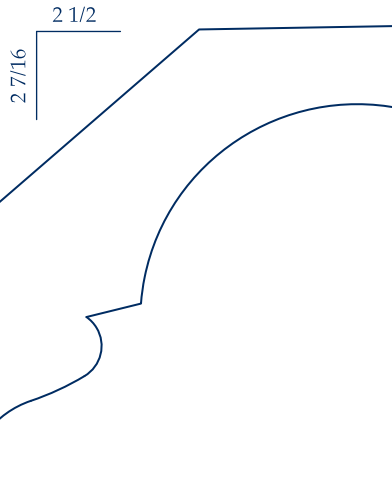

**IL 323**  
1 x 3 1/2

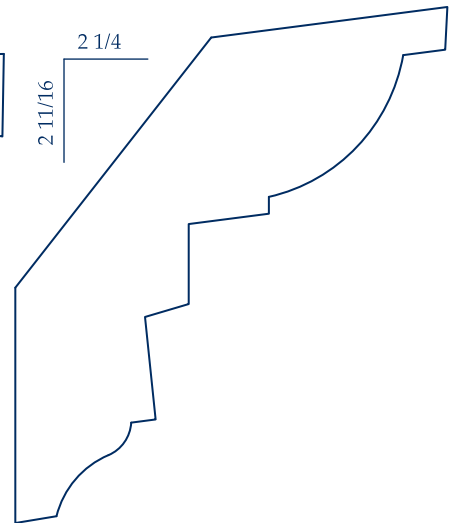

**IL 328**  
1 x 3 1/2





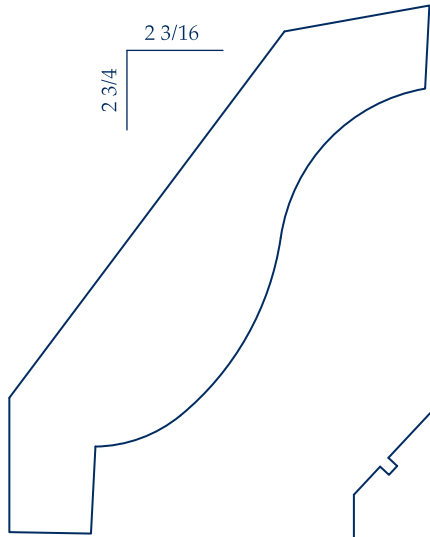

IL 342  
11/16 x 3 1/2  p.68

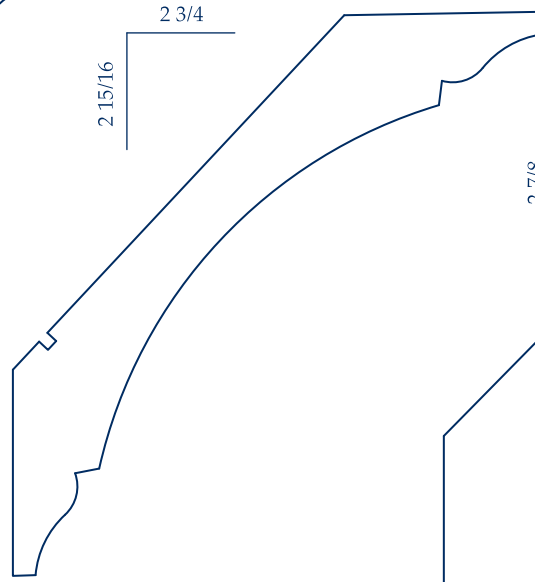

IL 365  
13/16 x 4  p.69

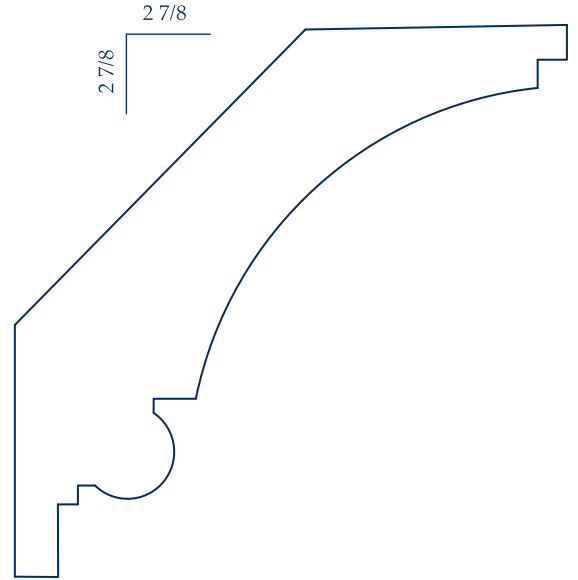

IL 367  
1 1/8 x 4 1/16  p.70

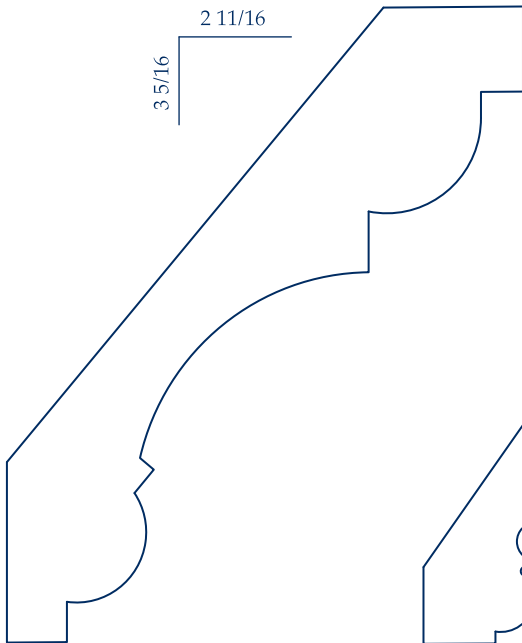

IL 305  
7/8 x 4 1/4

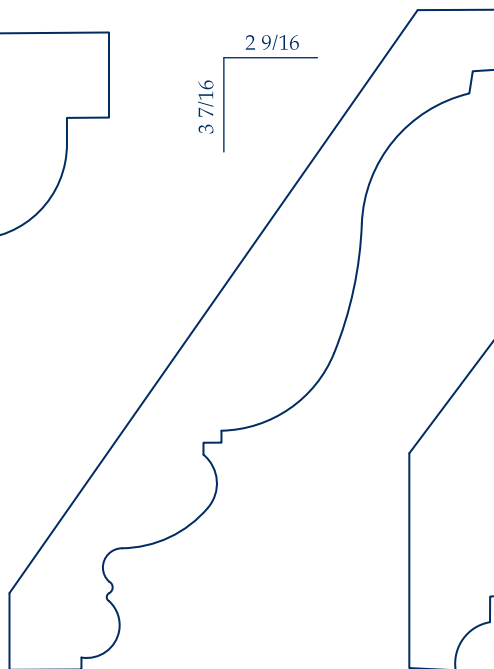

IL 301  
11/16 x 4 5/16

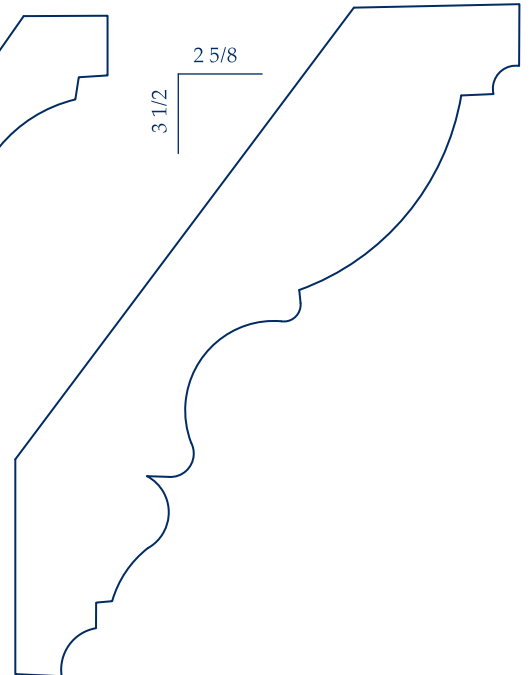

IL 362  
7/8 x 4 3/8

Profiles Shown 1:1

Greenwich, CT  
203.531.8050 914.939.2500

Bethel, CT  
203.748.5629

Newtown, CT  
203.364.0074

Stamford, CT  
203.348.3761

Westport, CT  
203.226.3321

Shrub Oak, NY  
914.245.5050



4"

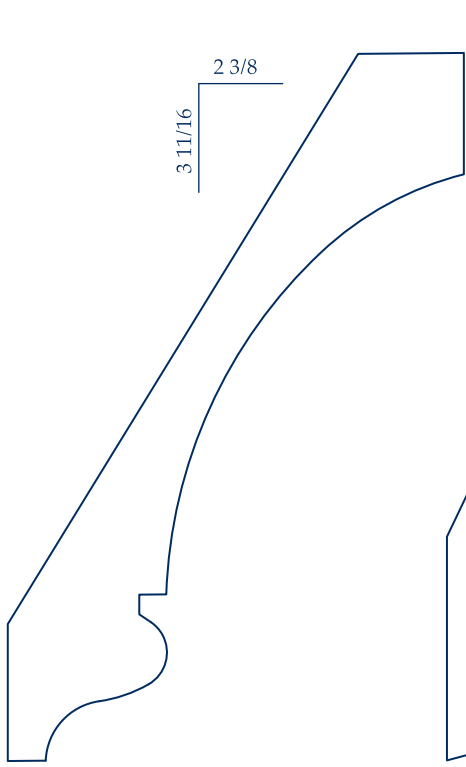

IL 348  
13/16 x 4 3/8

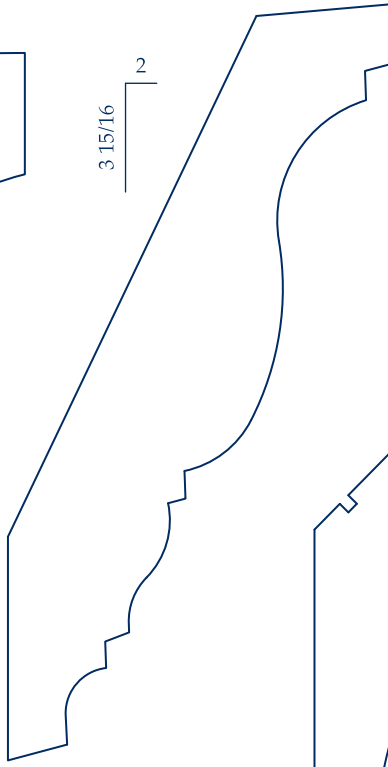

IL 325  
7/8 x 4 3/8

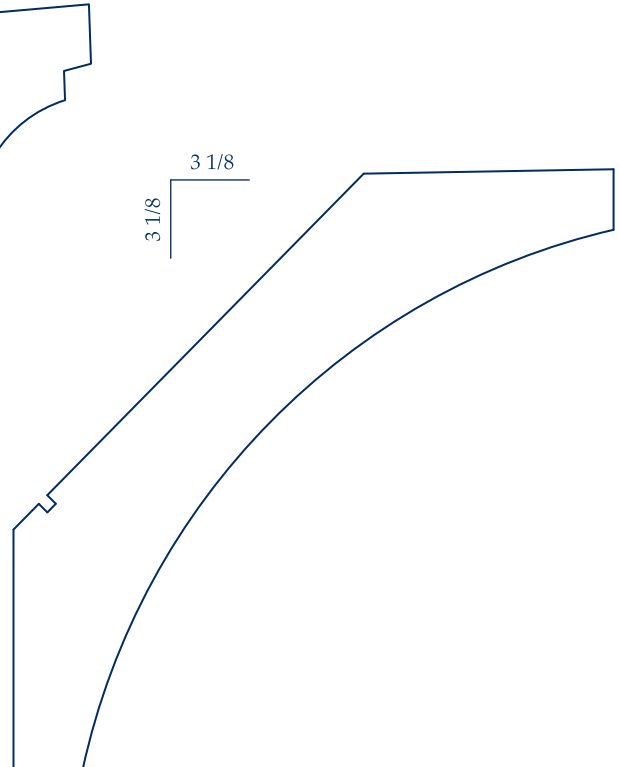

IL 371  
1 1/8 x 4 3/8

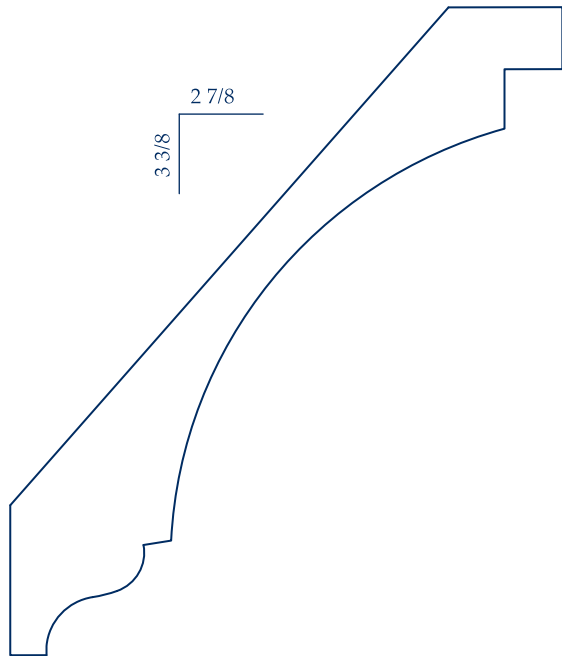

IL 304  
11/16 x 4 7/16

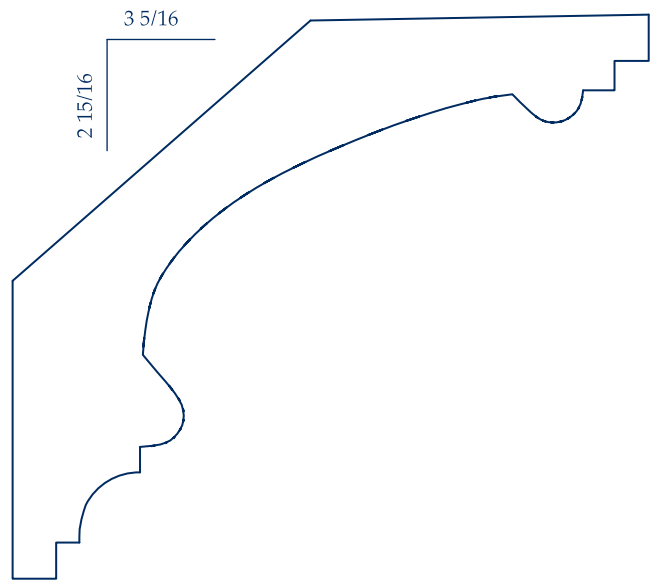

IL 376  
1 5/16 x 4 7/16



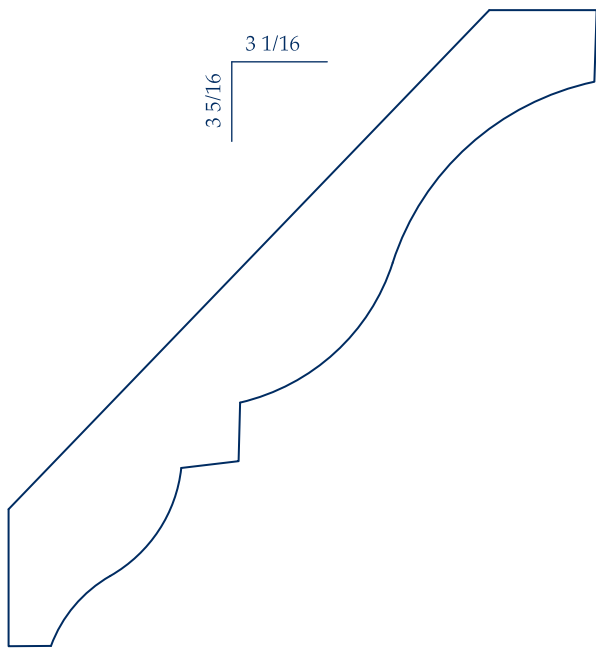

IL 311  
11/16 x 4 1/2

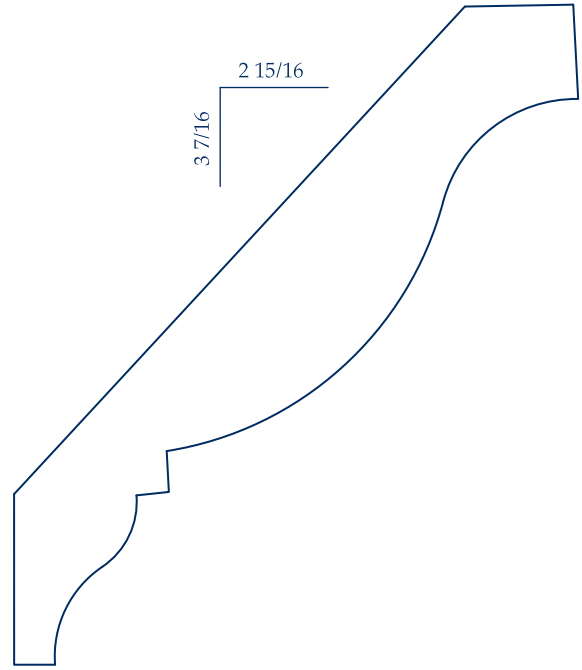

IL 386  
13/16 x 4 1/2



p.77

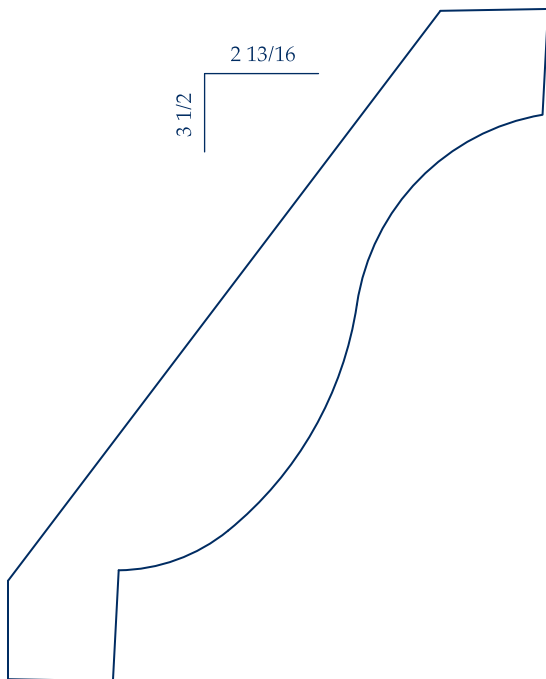

IL 363  
13/16 x 4 1/2



p.68

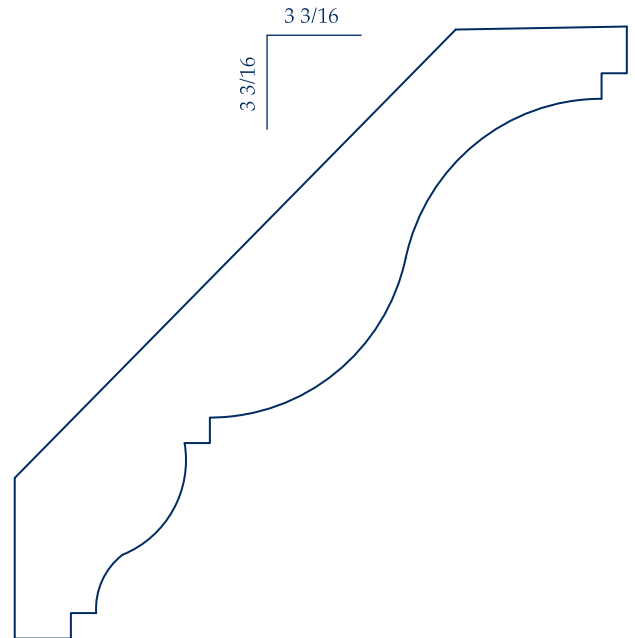

IL 388  
13/16 x 4 1/2



p.78

Profiles Shown 1:1

Greenwich, CT  
203.531.8050 914.939.2500

Bethel, CT  
203.748.5629

Newtown, CT  
203.364.0074

Stamford, CT  
203.348.3761

Westport, CT  
203.226.3321

Shrub Oak, NY  
914.245.5050



4"

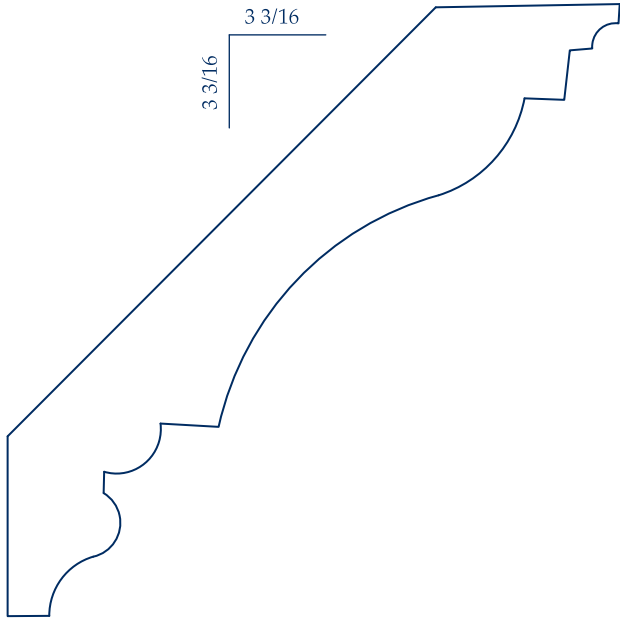

IL 378  
13/16 x 4 1/2  p.74

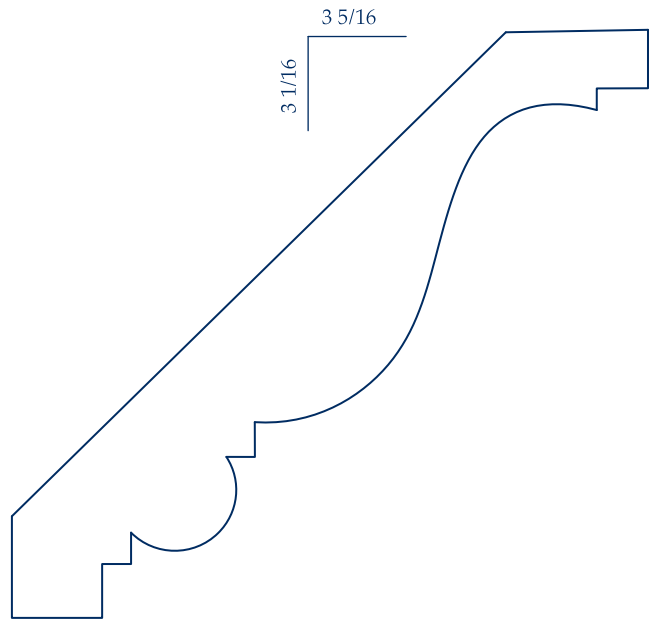

IL 383  
13/16 x 4 1/2  p.76

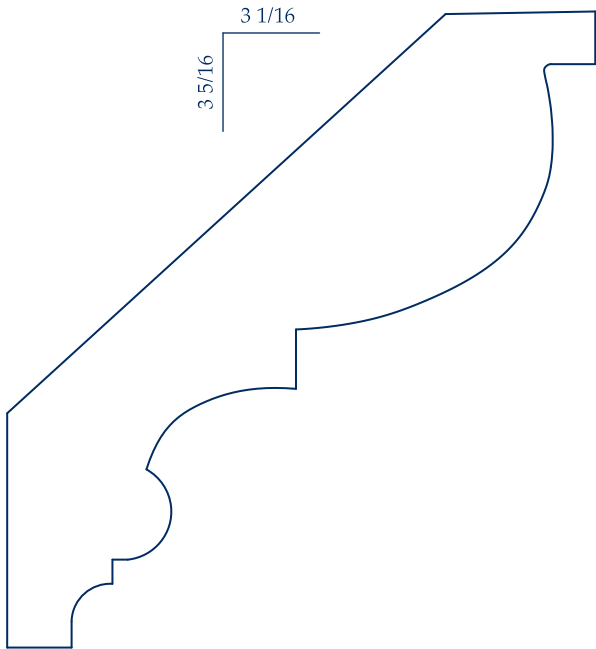

IL 380  
1 1/8 x 4 1/2  p.75

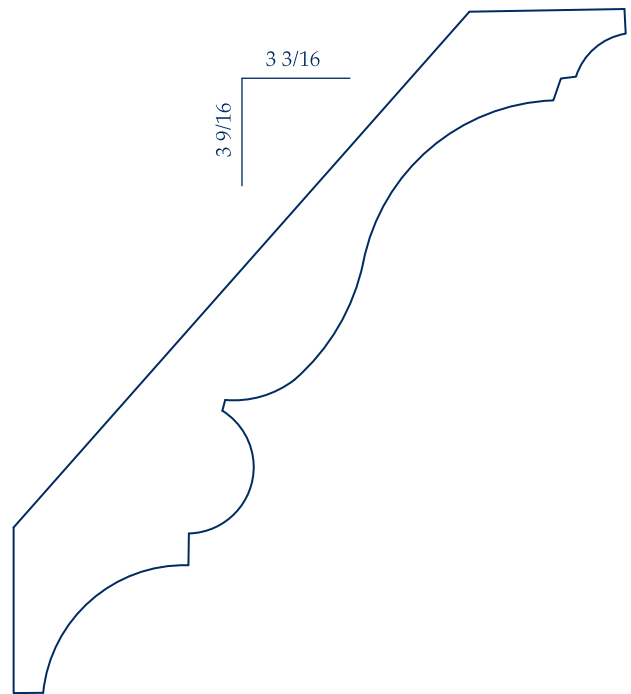

IL 391  
13/16 x 4 3/4  p.79



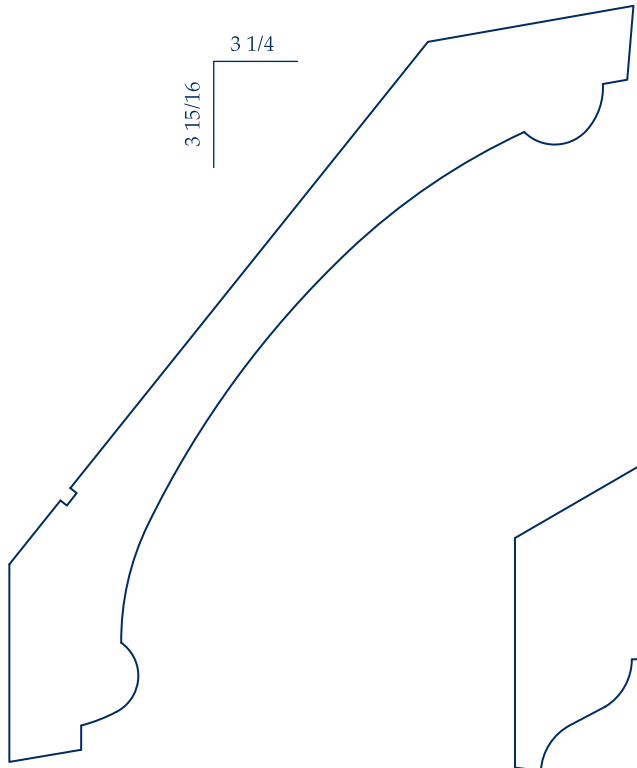

IL 352  
15/16 x 5 1/8

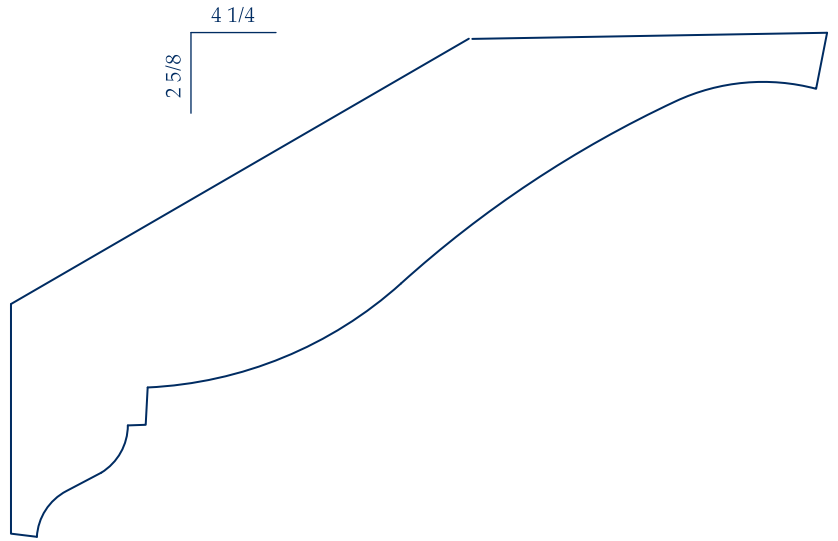

IL 393  
1 1/8 x 5

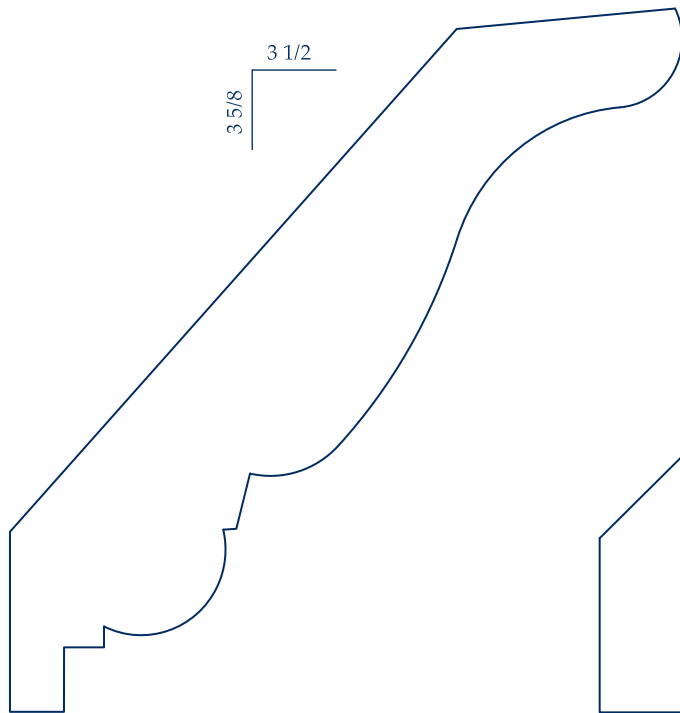

IL 339  
1 x 5

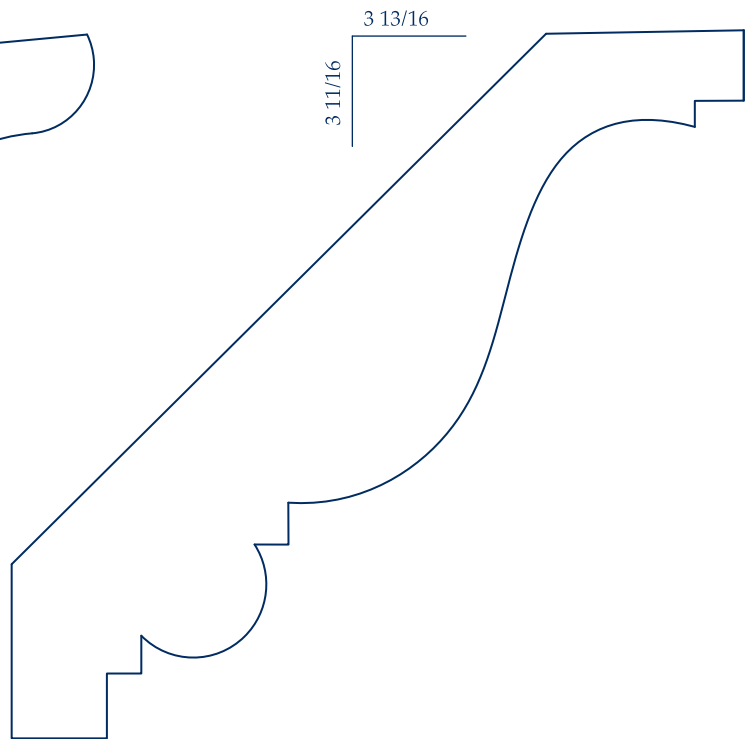

IL 384  
1 1/8 x 5 5/16



Profiles Shown 1:1

Greenwich, CT  
203.531.8050 914.939.2500

Bethel, CT  
203.748.5629

Newtown, CT  
203.364.0074

Stamford, CT  
203.348.3761

Westport, CT  
203.226.3321

Shrub Oak, NY  
914.245.5050



5"

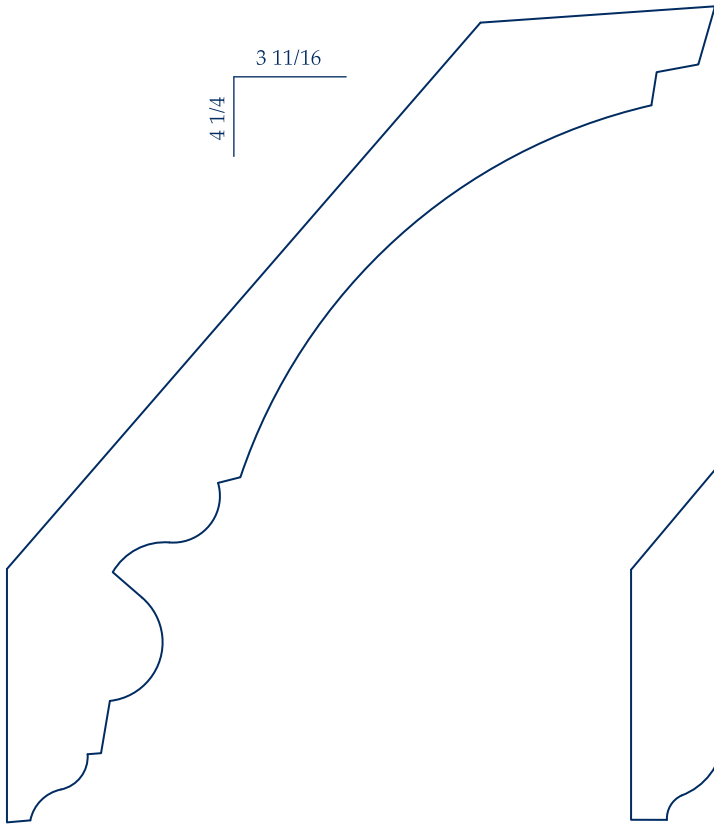

IL 344  
1 x 5 5/8

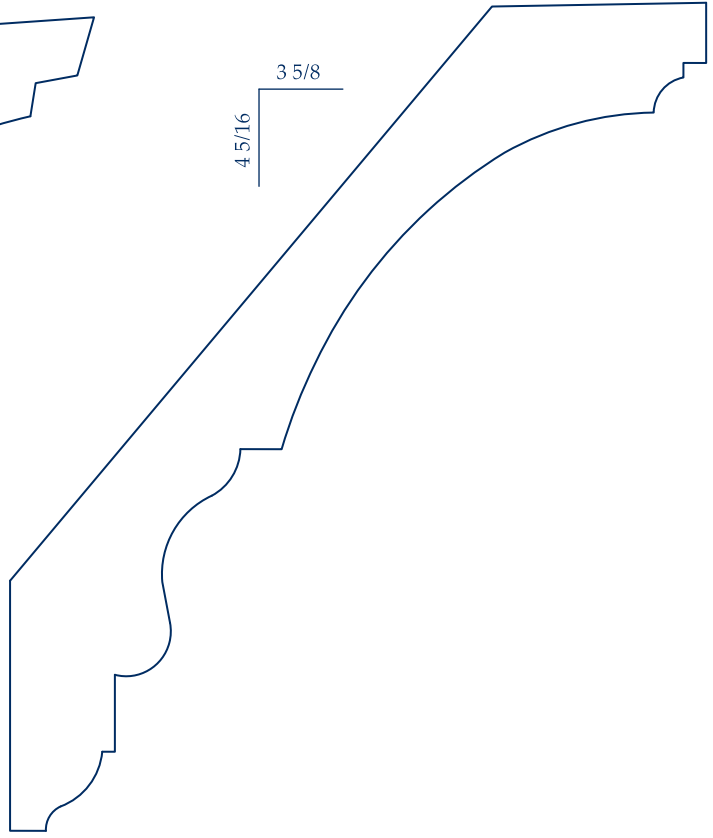

IL 303  
1 x 5 5/8

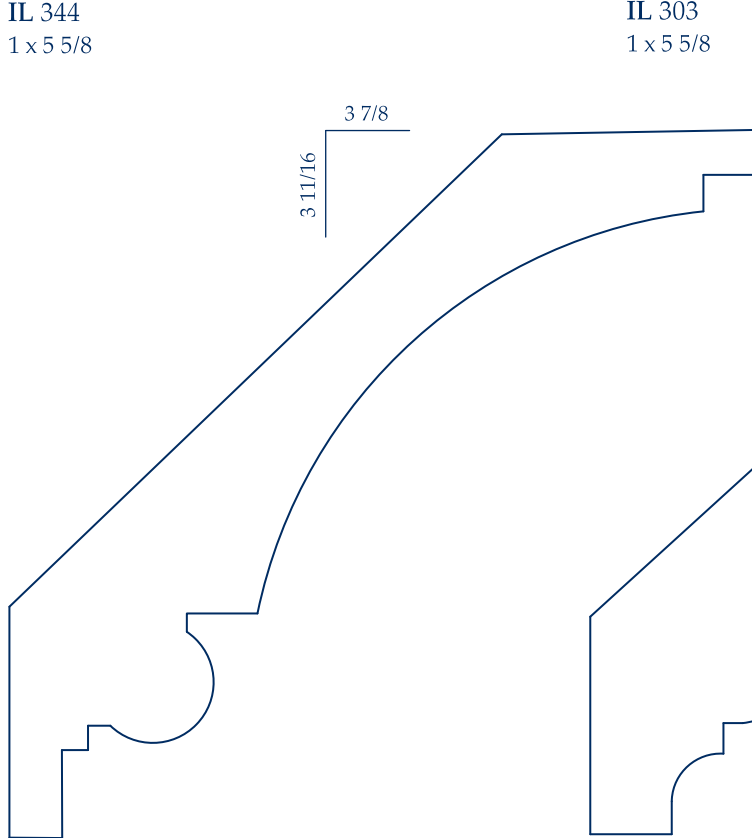

IL 368  
1 1/8 x 5 3/8 

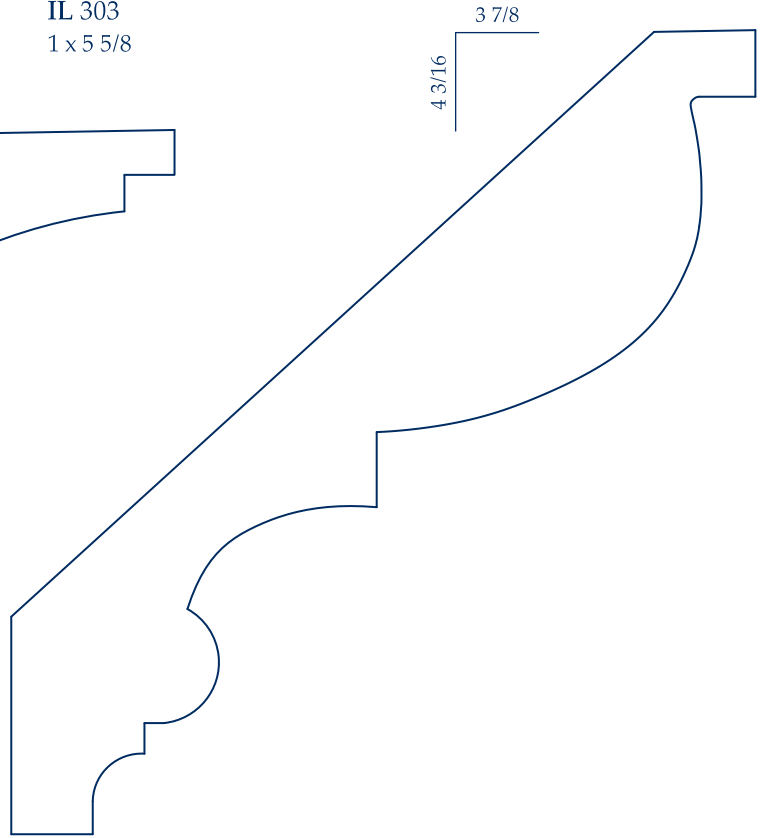

IL 381  
1 1/8 x 5 11/16 



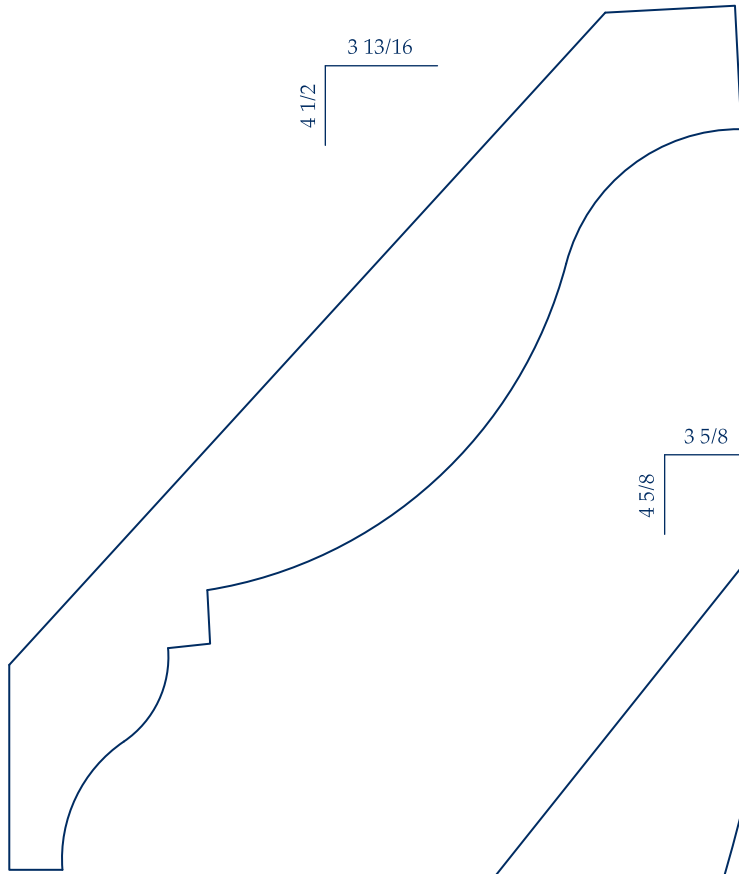

IL 326  
1 x 5 7/8

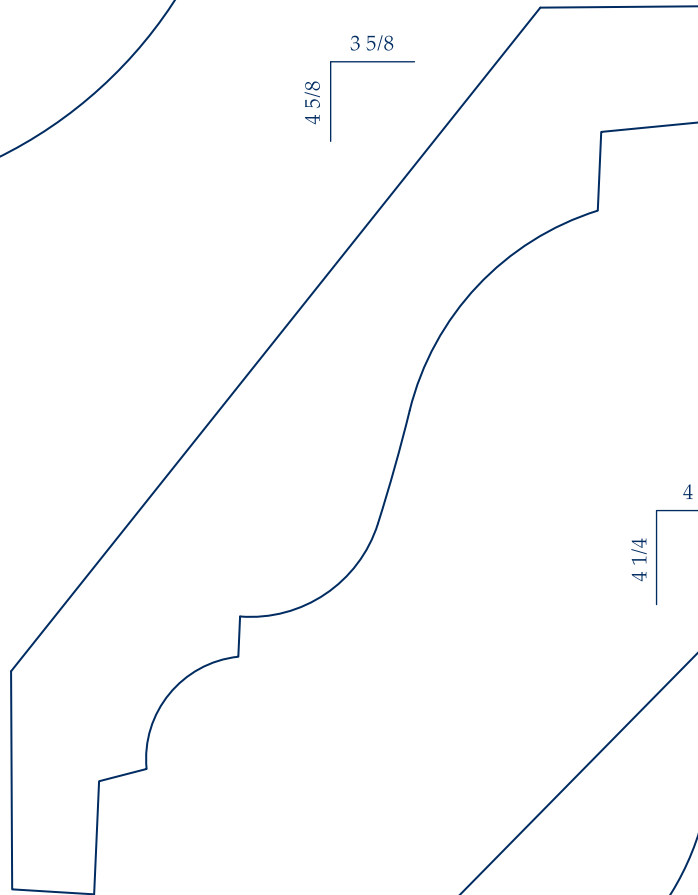

IL 321  
1 1/16 x 5 7/8

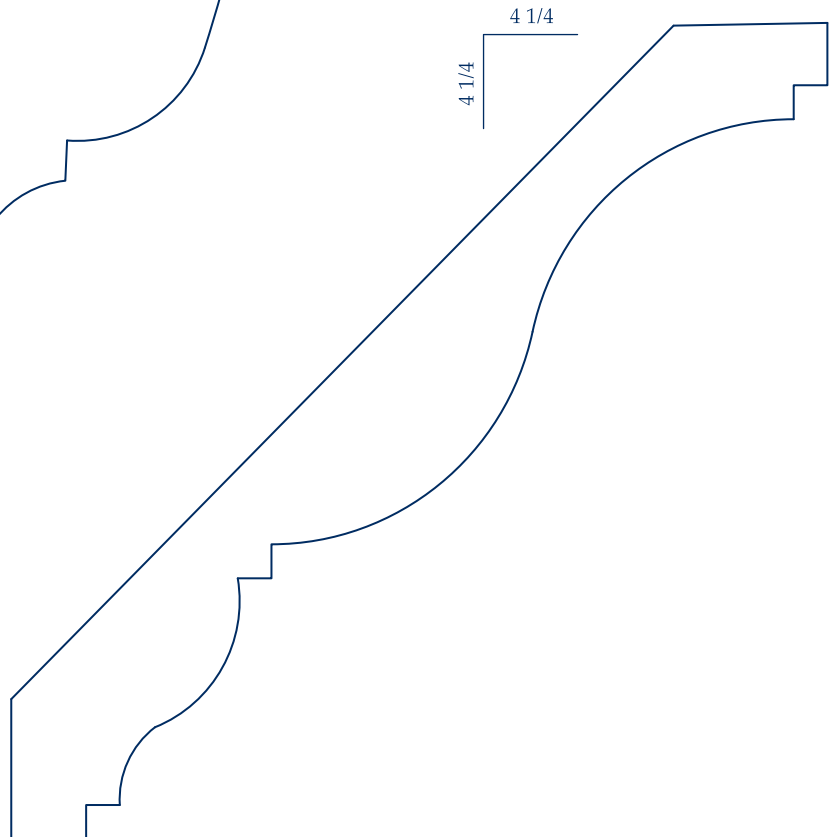

IL 389  
13/16 x 6



Profiles Shown 1:1

Greenwich, CT  
203.531.8050 914.939.2500

Bethel, CT  
203.748.5629

Newtown, CT  
203.364.0074

Stamford, CT  
203.348.3761

Westport, CT  
203.226.3321

Shrub Oak, NY  
914.245.5050





6"

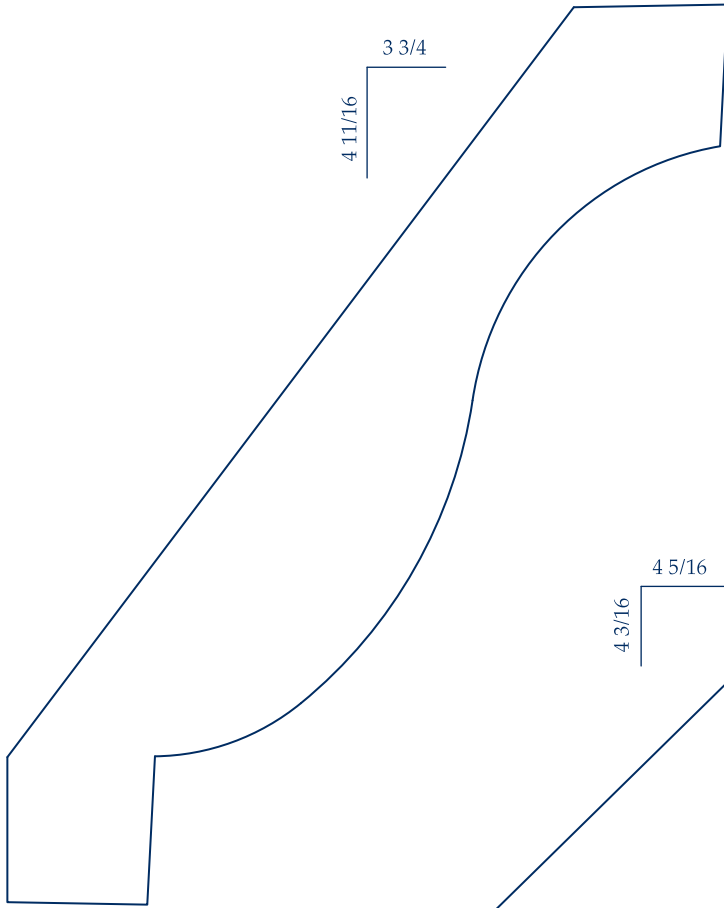

IL 364  
1 1/8 x 6

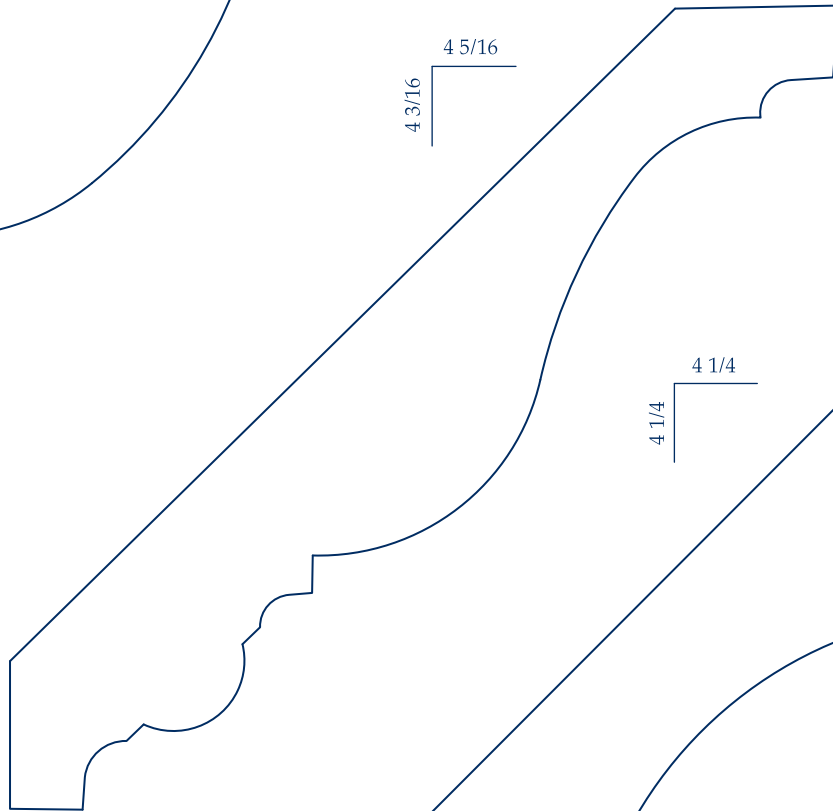

IL 306  
1 1/16 x 6

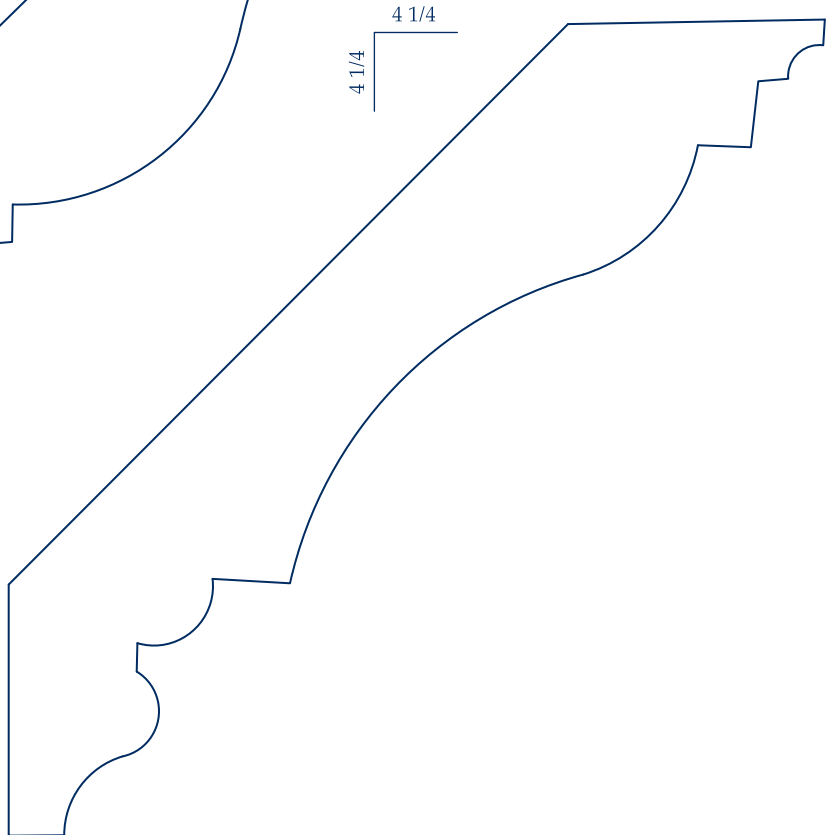

IL 379  
1 1/8 x 6



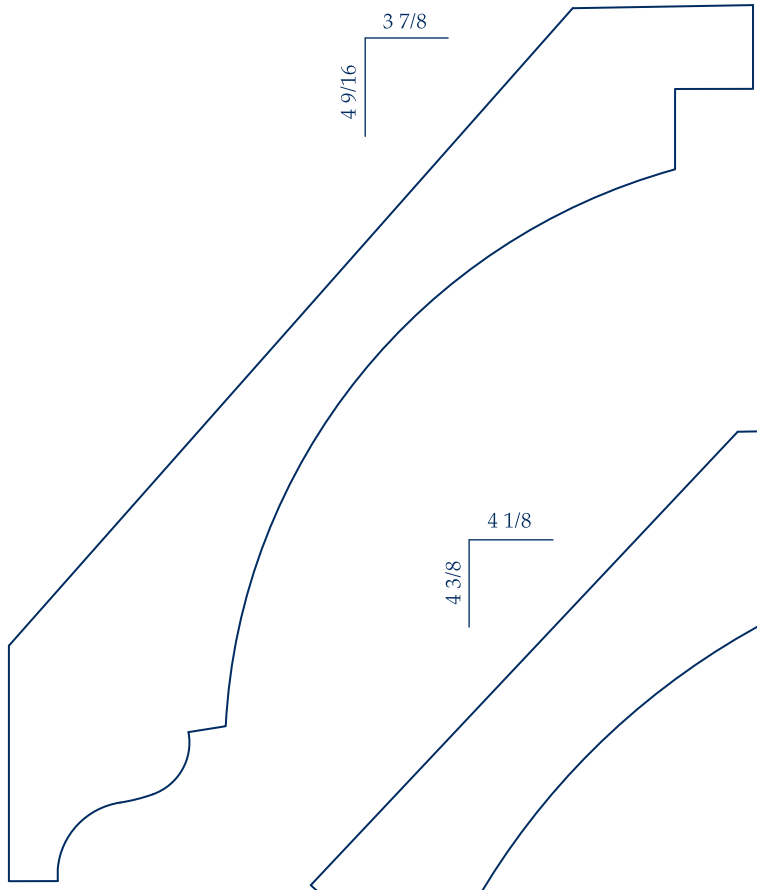

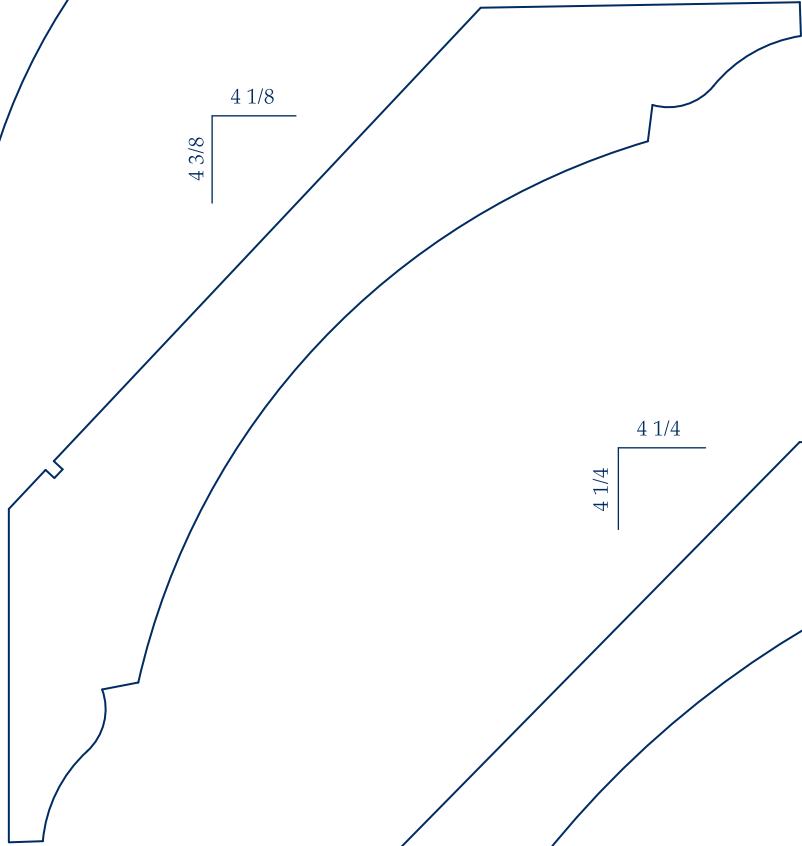

IL 374  
1 1/8 x 6  p.72

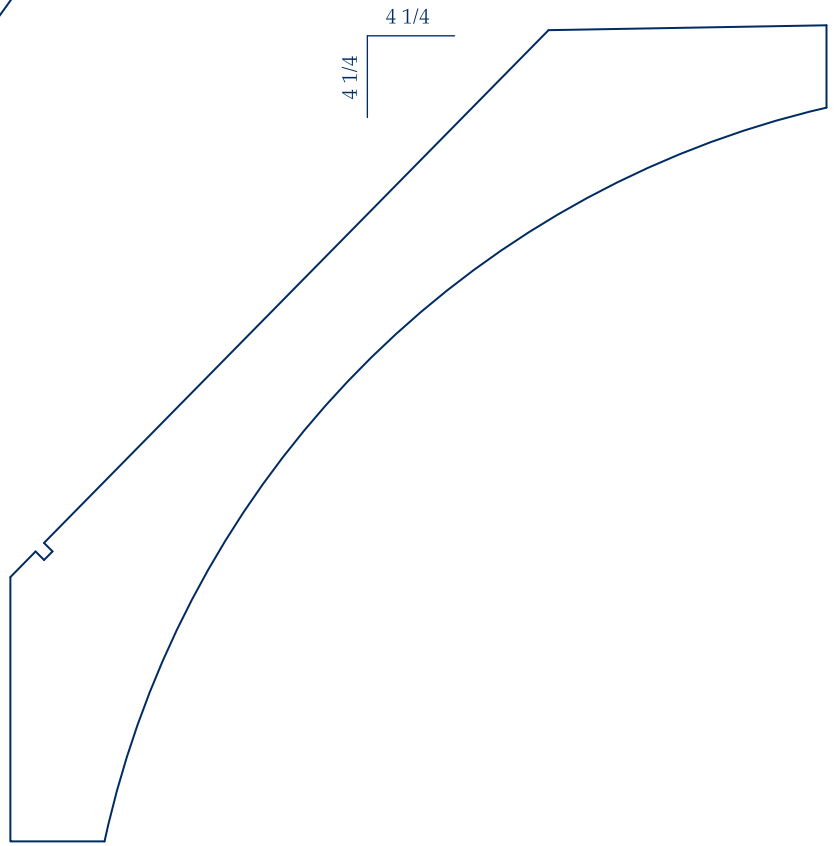

IL 366  
1 5/16 x 6  p.69



IL 372  
1 5/16 x 6  p.71

Profiles Shown 1:1

Greenwich, CT  
203.531.8050 914.939.2500

Bethel, CT  
203.748.5629

Newtown, CT  
203.364.0074

Stamford, CT  
203.348.3761

Westport, CT  
203.226.3321

Shrub Oak, NY  
914.245.5050



6"

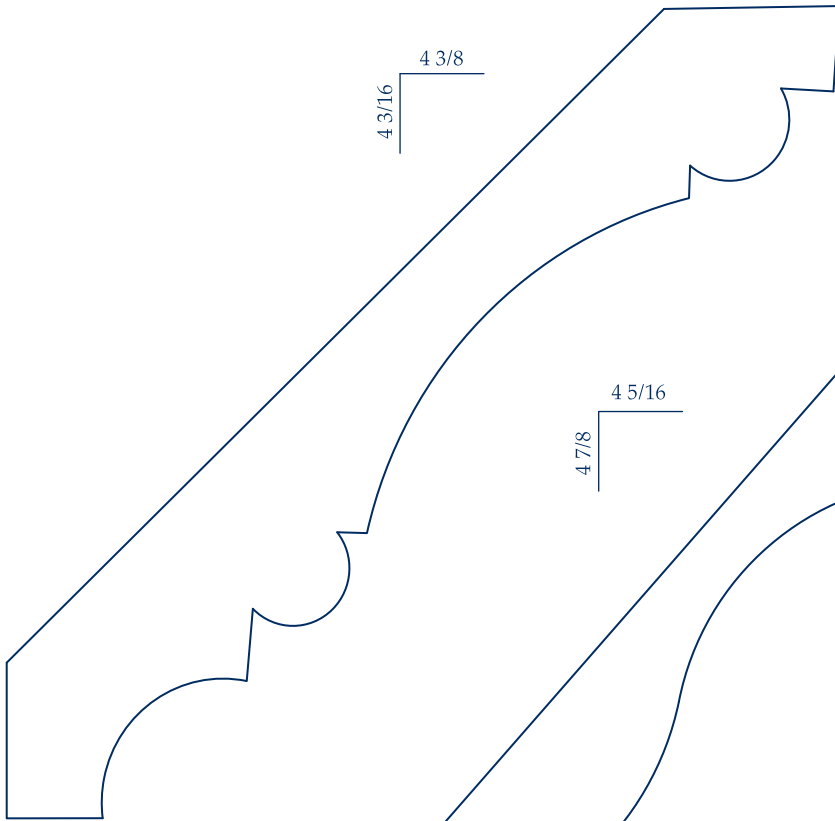

IL 361  
1 x 6 1/16

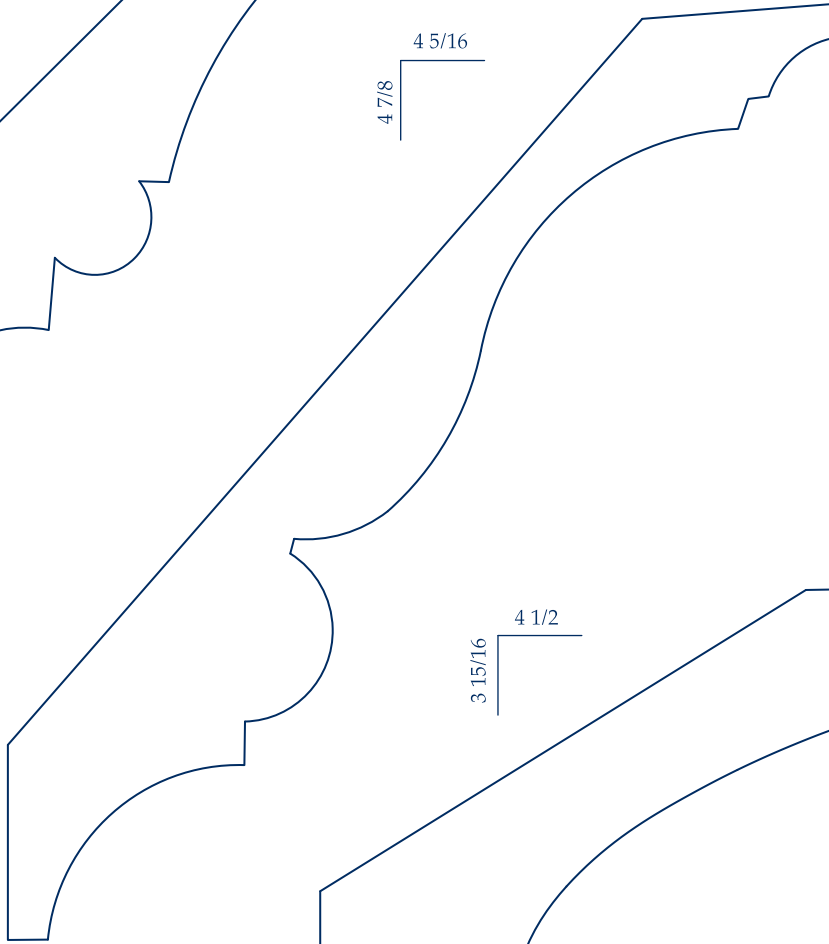

IL 356  
1 x 6 1/2

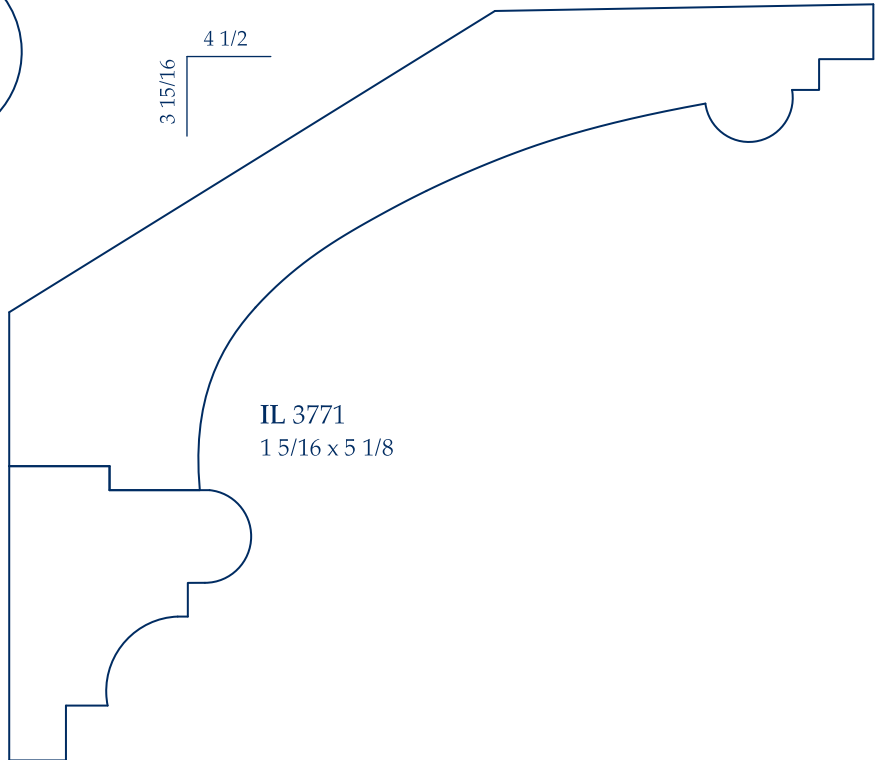

IL 3771  
1 5/16 x 5 1/8

IL 3772  
1 9/16 x 1 1/4



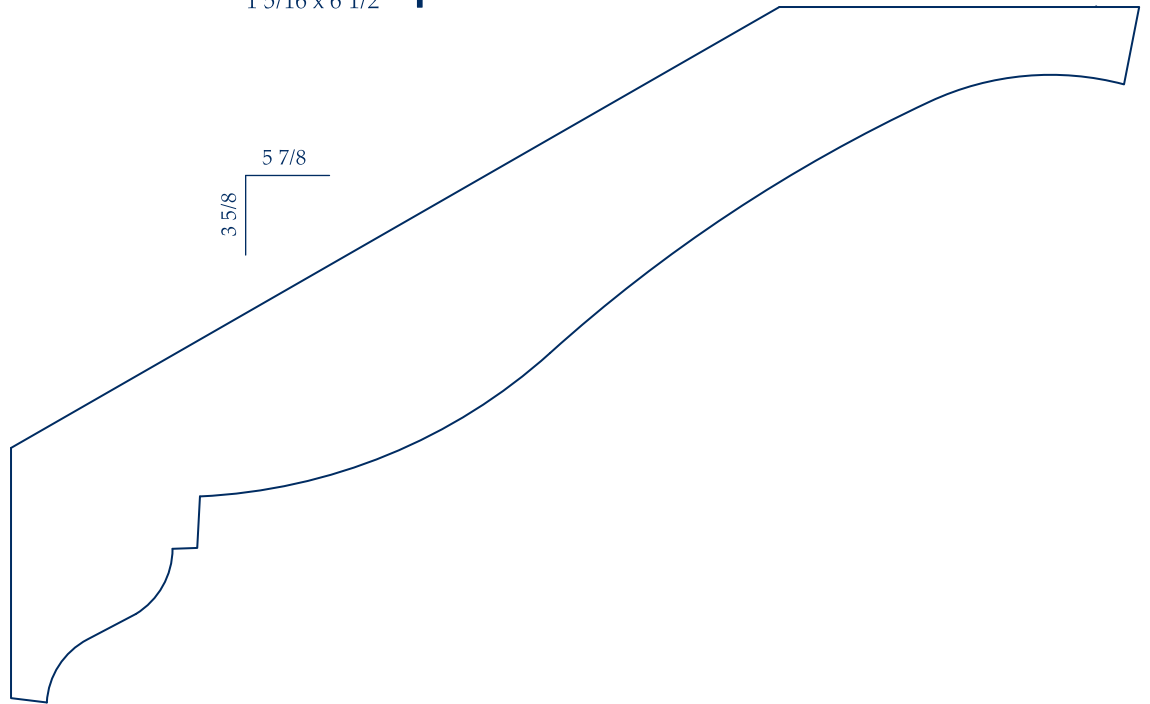
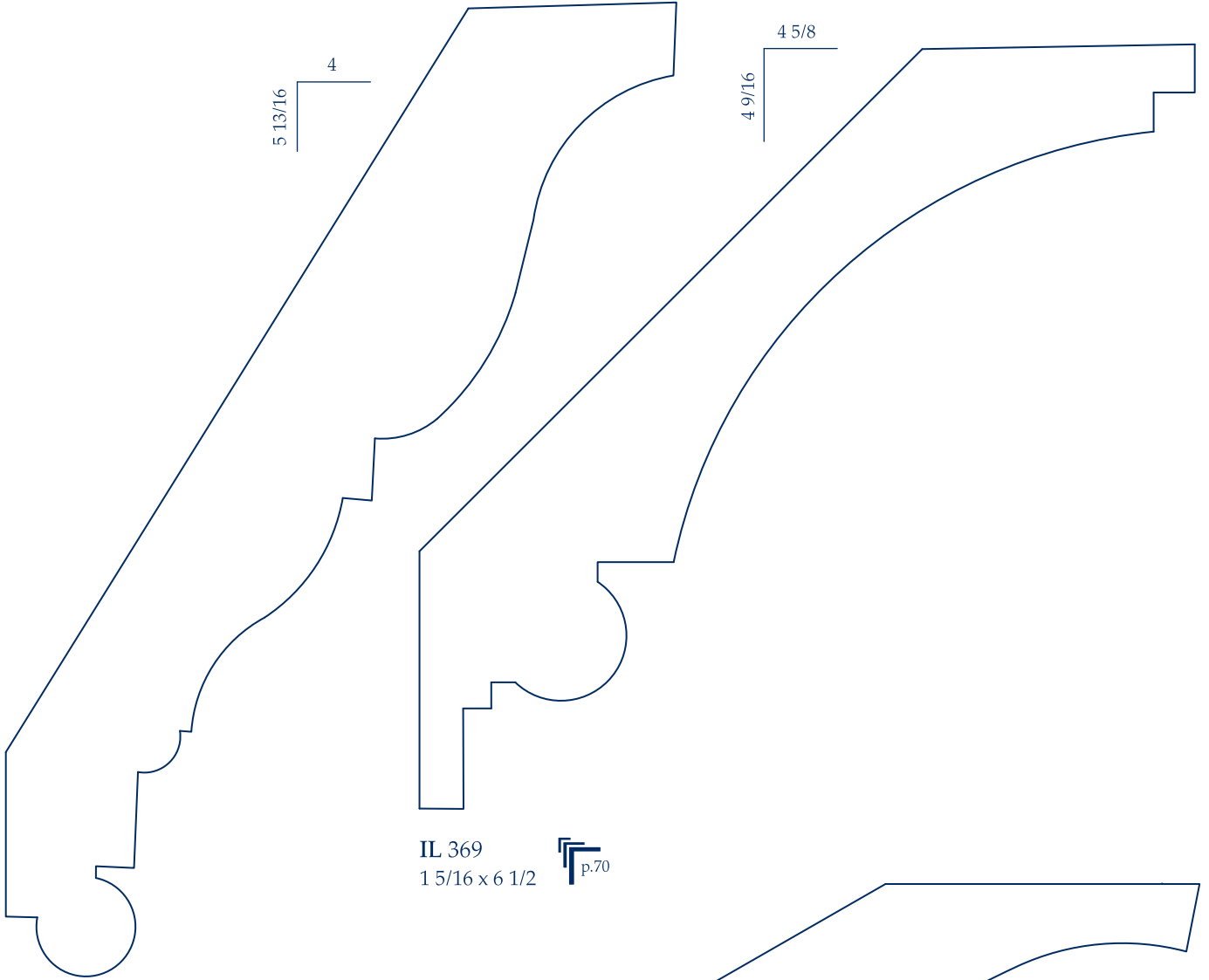

Profiles Shown 1:1

Greenwich, CT  
203.531.8050 914.939.2500

Bethel, CT  
203.748.5629

Newtown, CT  
203.364.0074

Stamford, CT  
203.348.3761

Westport, CT  
203.226.3321

Shrub Oak, NY  
914.245.5050



7"

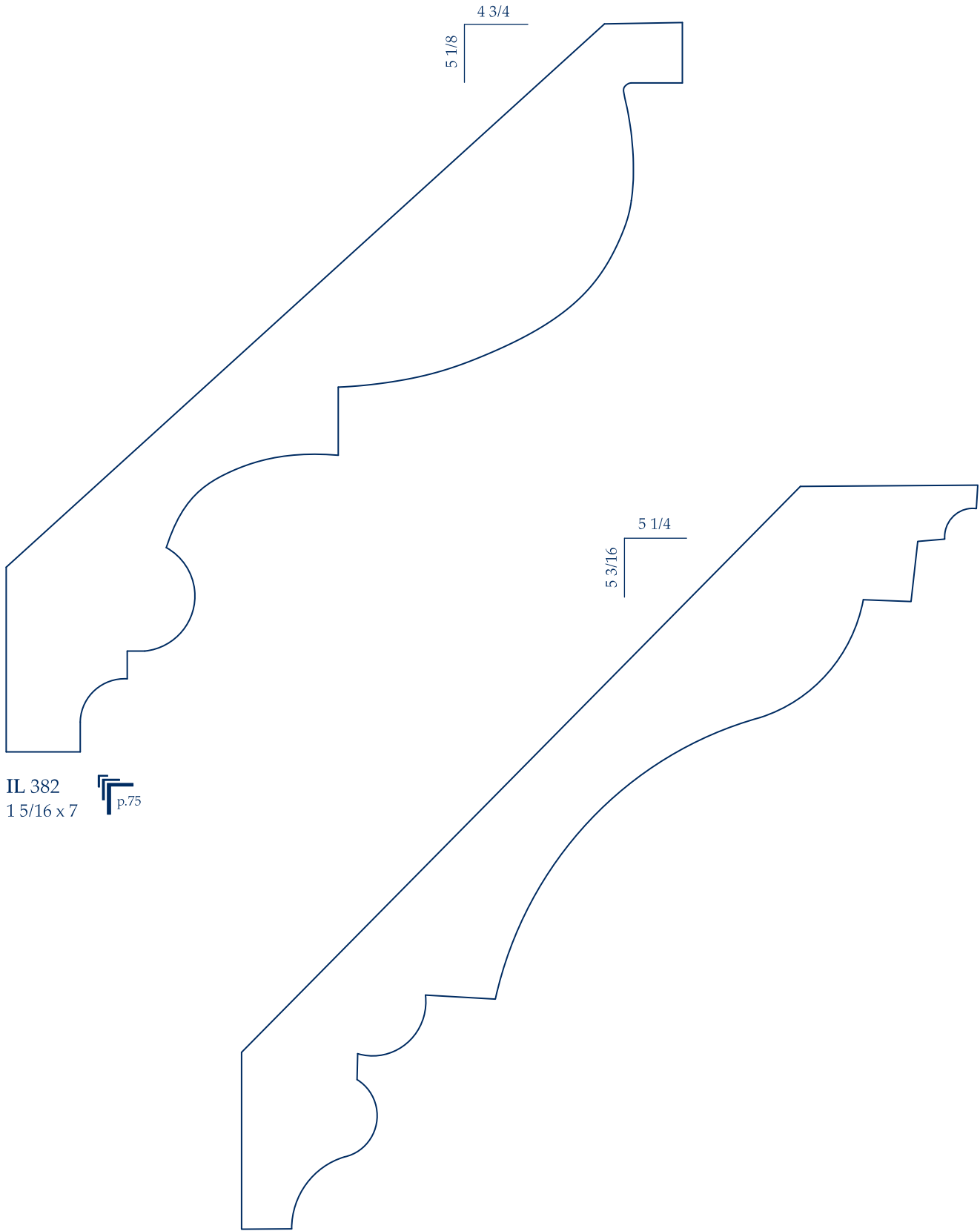

IL 382  
1 5/16 x 7



p.75

IL 357  
1 1/8 x 7 3/8



p.74



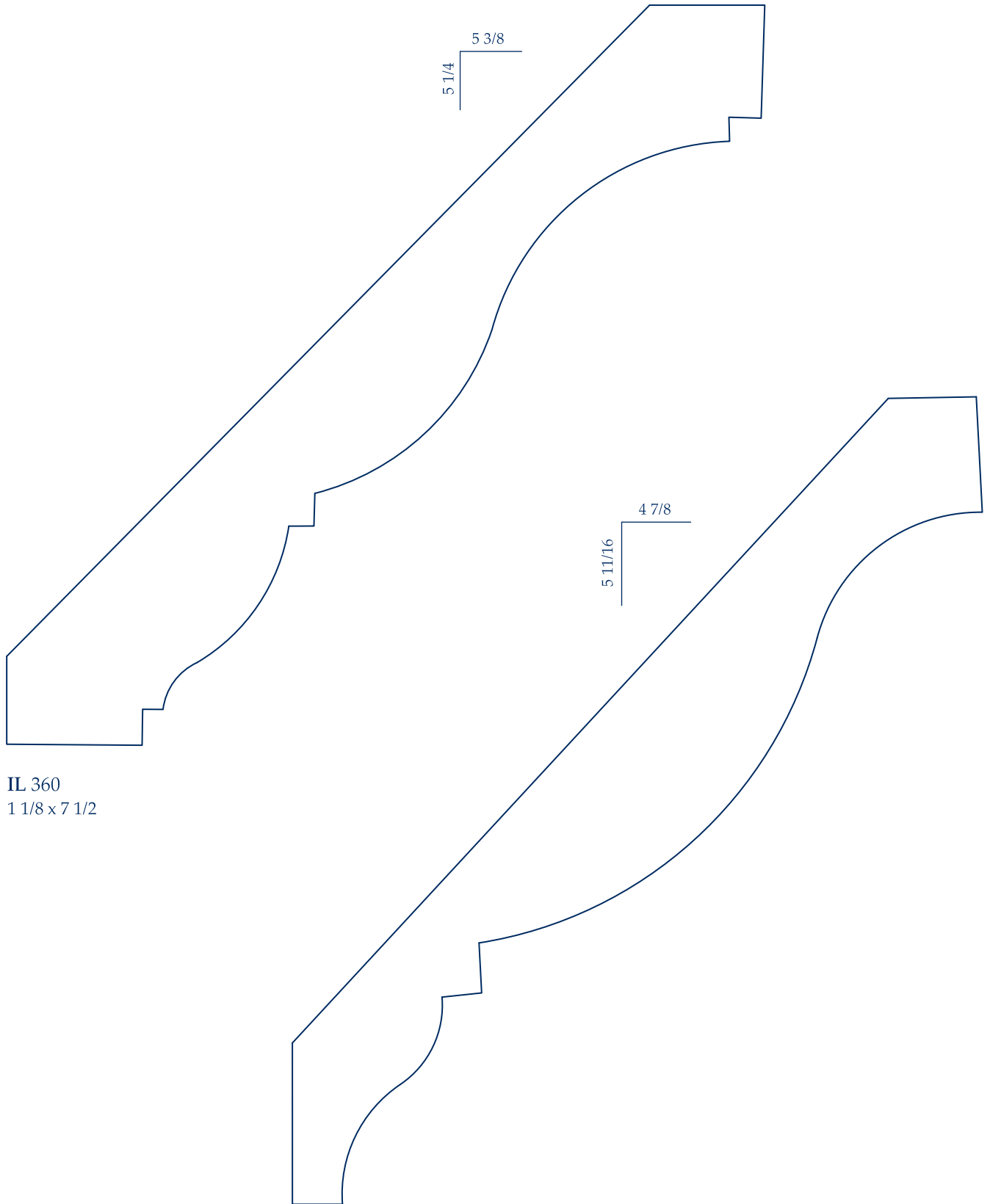

IL 360  
1 1/8 x 7 1/2

IL 387  
1 1/8 x 7 1/2



Profiles Shown 1:1

Greenwich, CT  
203.531.8050 914.939.2500

Bethel, CT  
203.748.5629

Newtown, CT  
203.364.0074

Stamford, CT  
203.348.3761

Westport, CT  
203.226.3321

Shrub Oak, NY  
914.245.5050



7"

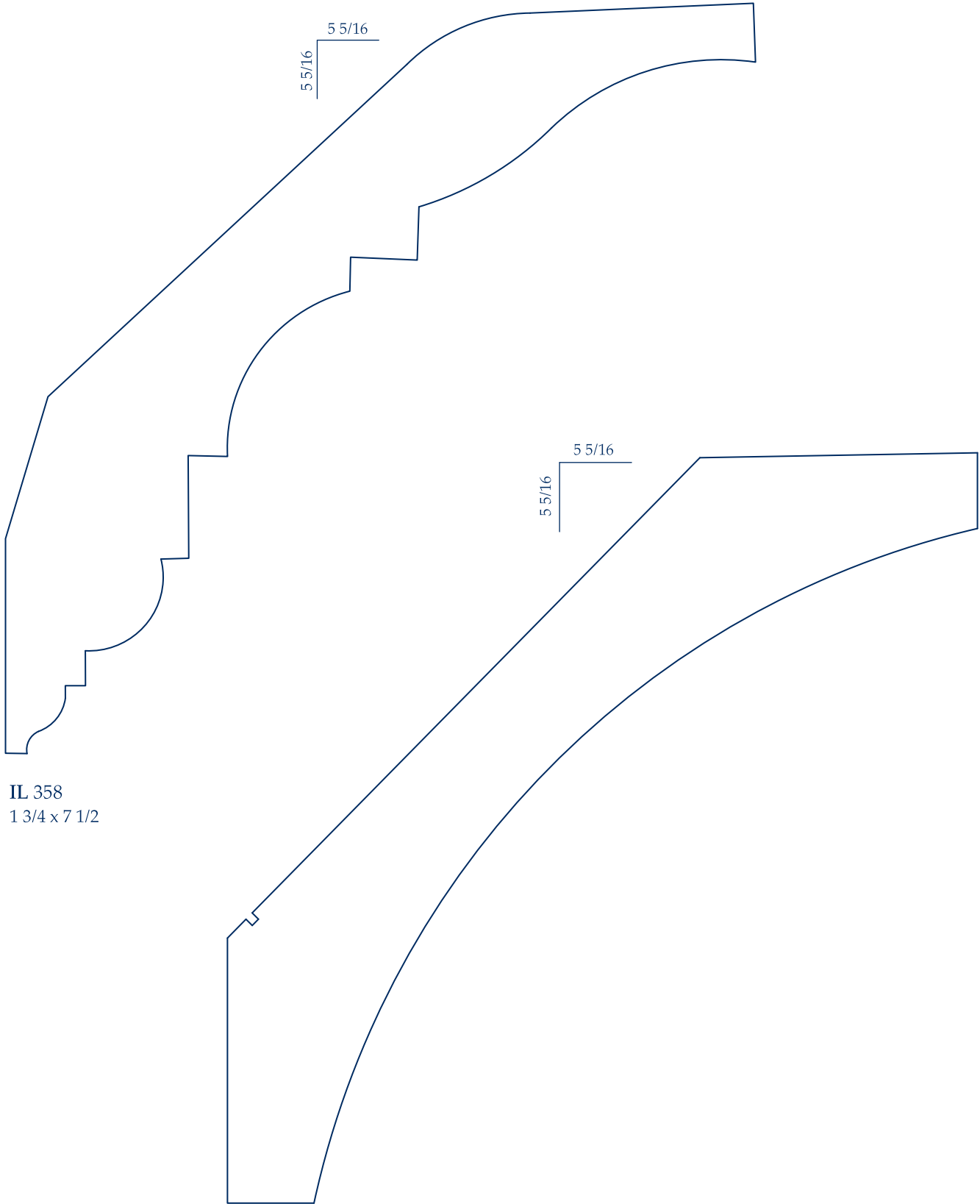

IL 358  
1 3/4 x 7 1/2

IL 373  
1 3/4 x 7 1/2



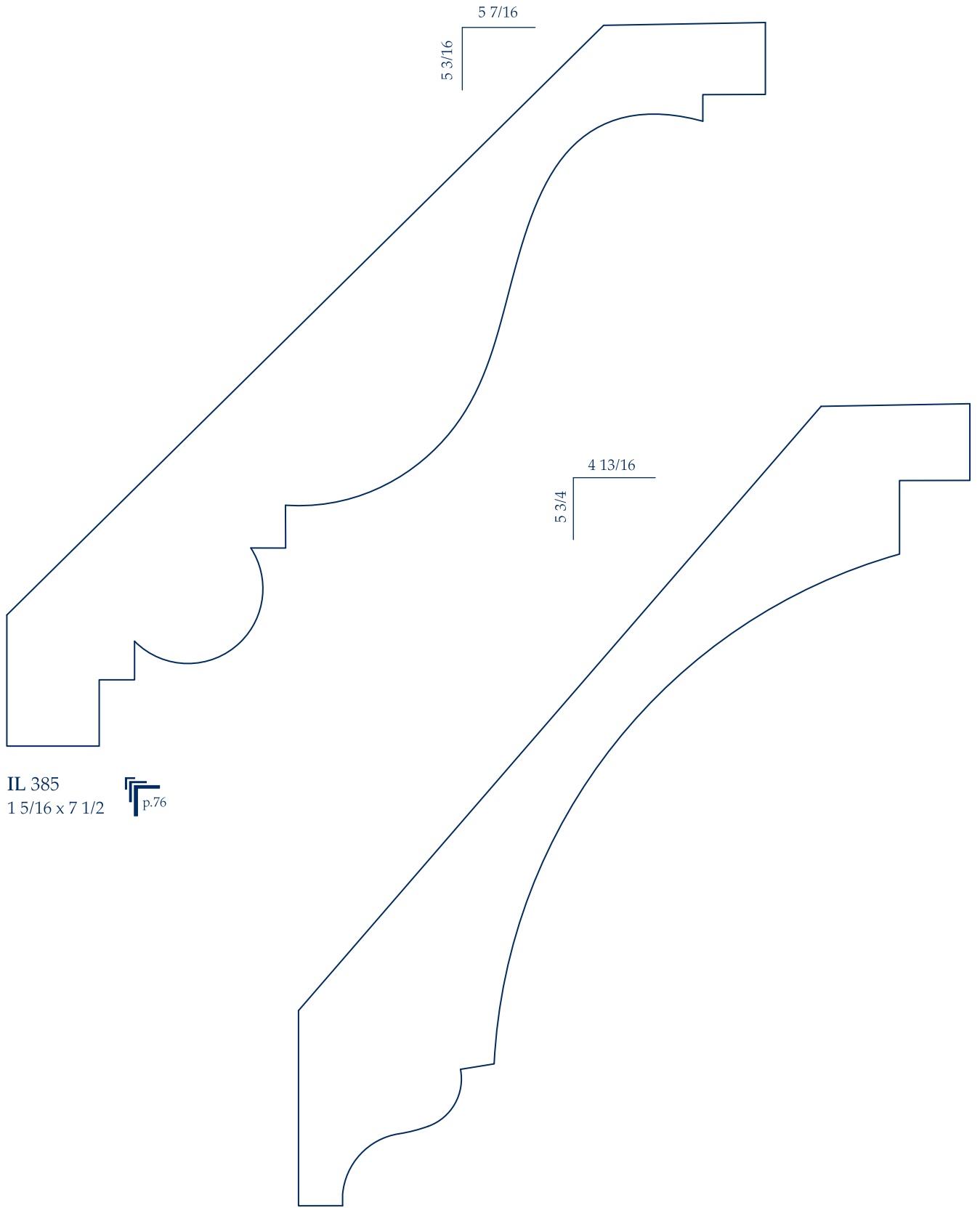

IL 385  
1 5/16 x 7 1/2



p.76

IL 375  
1 5/16 x 7 1/2



p.72

Profiles Shown 1:1

Greenwich, CT  
203.531.8050 914.939.2500

Bethel, CT  
203.748.5629

Newtown, CT  
203.364.0074

Stamford, CT  
203.348.3761

Westport, CT  
203.226.3321

Shrub Oak, NY  
914.245.5050





7"

5 1/4  
5 9/16

5 7/16  
5 3/8

IL 331  
1 x 7 5/8

IL 390  
1 1/8 x 7 11/16



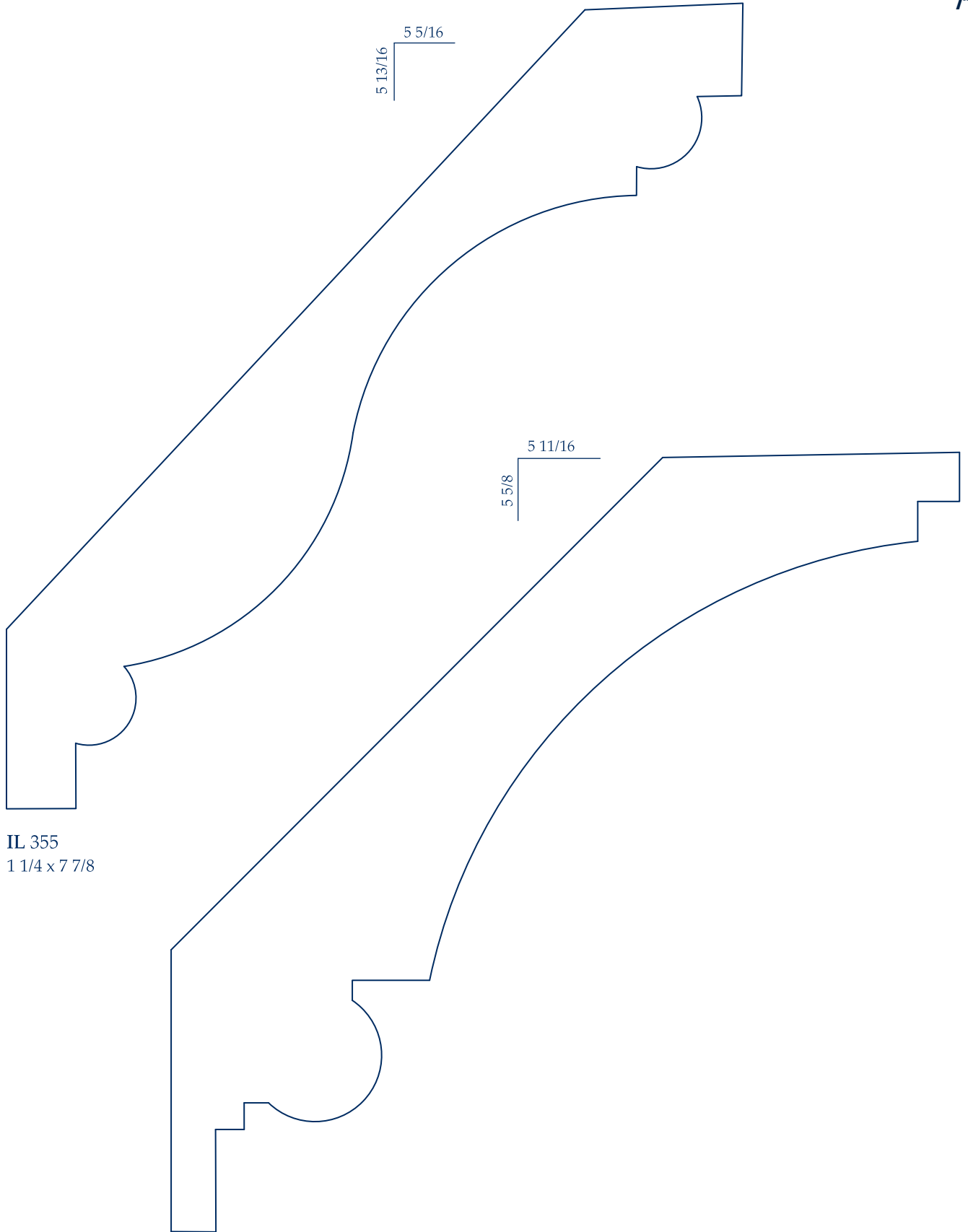

IL 355  
1 1/4 x 7 7/8

IL 370  
1 3/4 x 8



Profiles Shown 1:1

Greenwich, CT  
203.531.8050 914.939.2500

Bethel, CT  
203.748.5629

Newtown, CT  
203.364.0074

Stamford, CT  
203.348.3761

Westport, CT  
203.226.3321

Shrub Oak, NY  
914.245.5050



8"

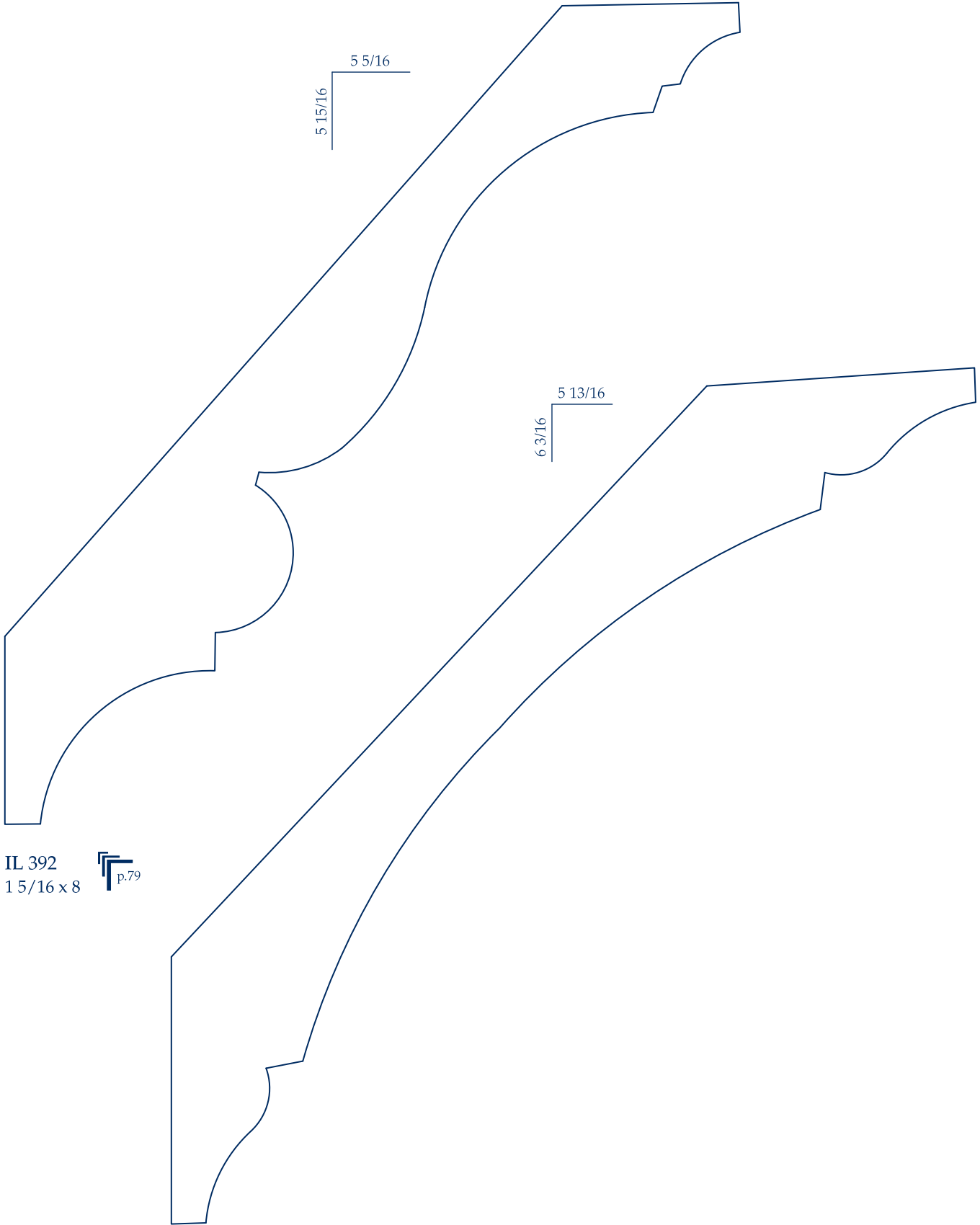

IL 392  
1 5/16 x 8



p.79

IL 345  
1 1/2 x 8 1/2



p.69

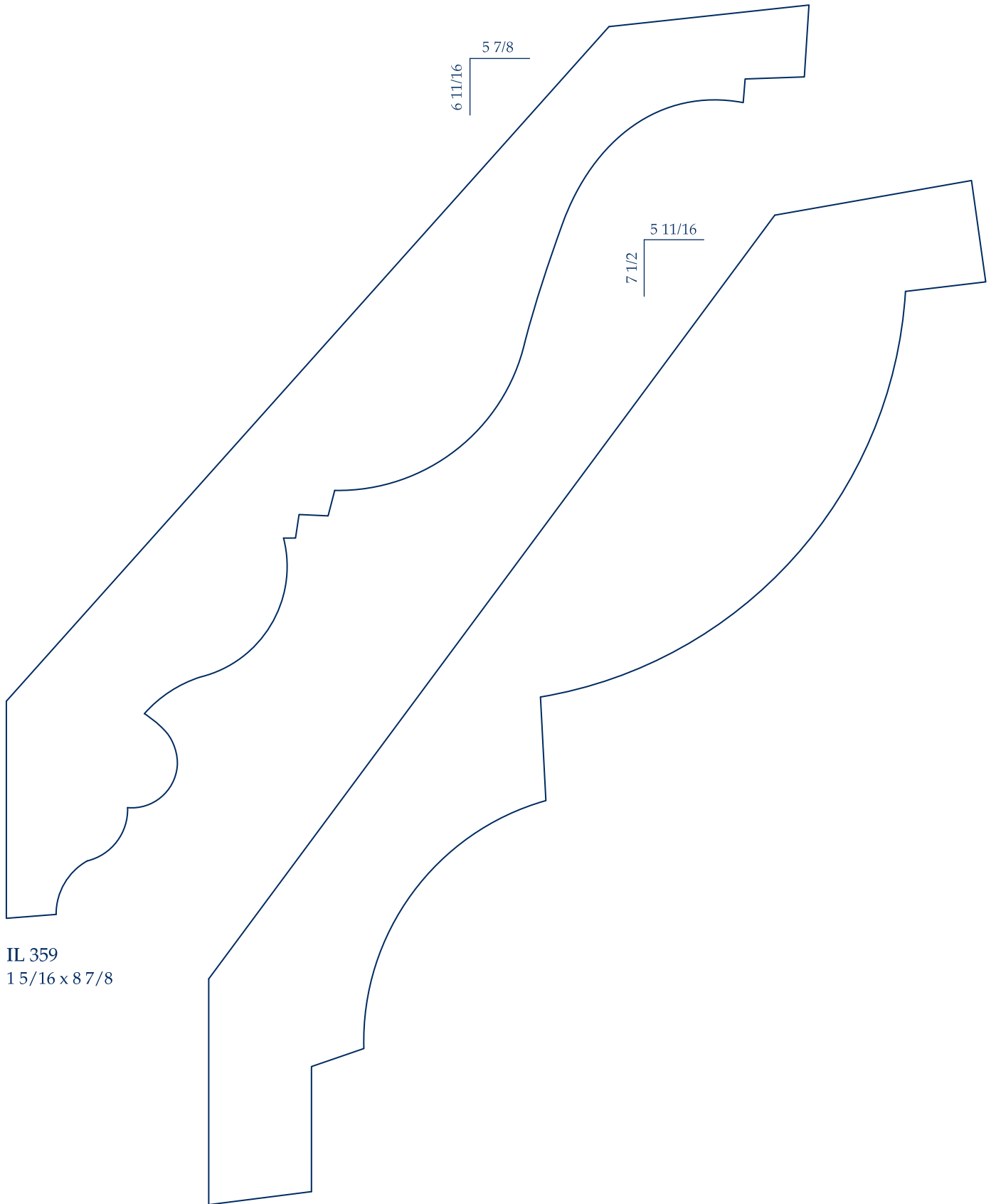

IL 359  
15/16 x 8 7/8

IL 335  
15/8 x 9 3/8

Profiles Shown 1:1

Greenwich, CT  
203.531.8050 914.939.2500

Bethel, CT  
203.748.5629

Newtown, CT  
203.364.0074

Stamford, CT  
203.348.3761

Westport, CT  
203.226.3321

Shrub Oak, NY  
914.245.5050



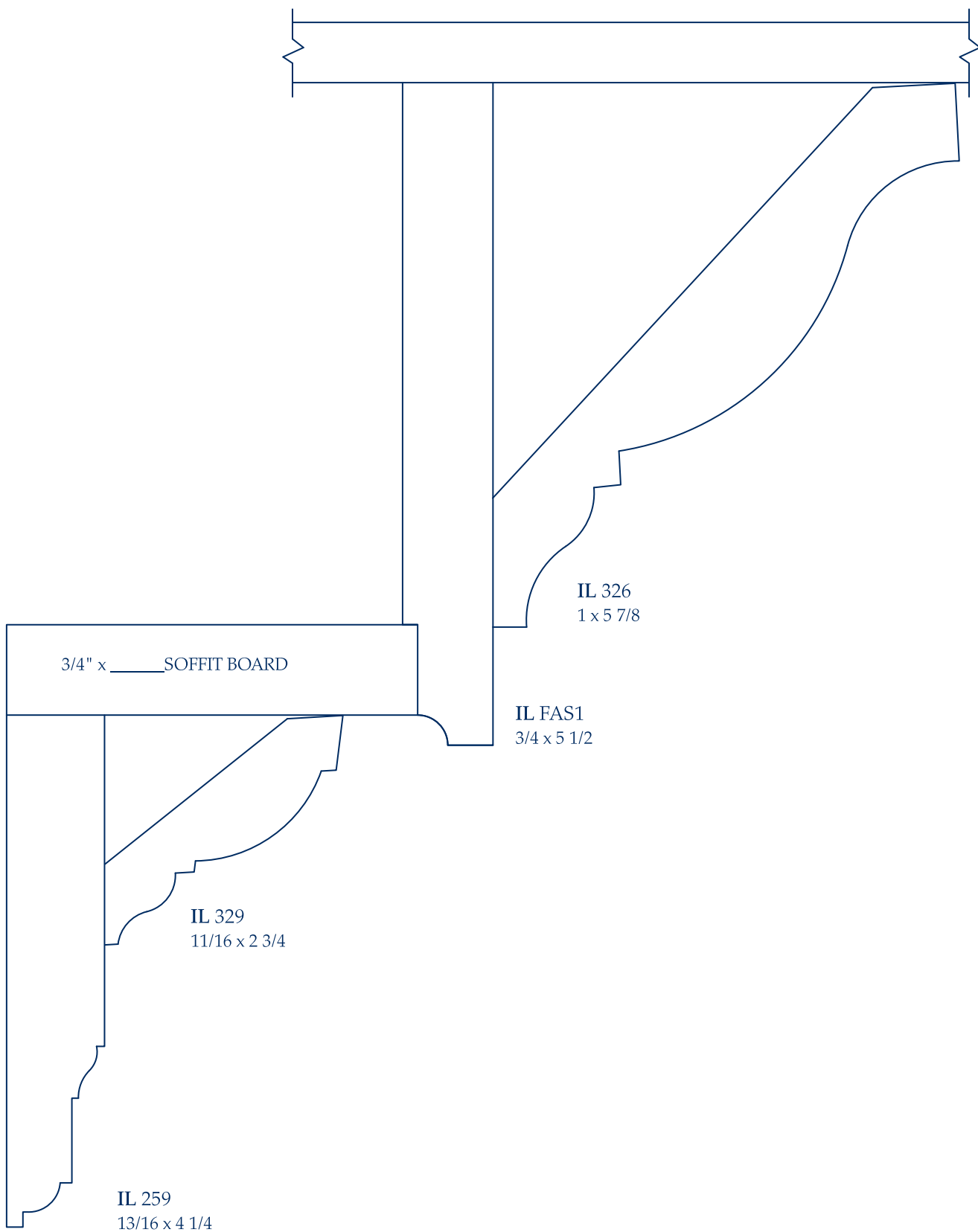

IL FAS2  
3/4 x 5 1/2

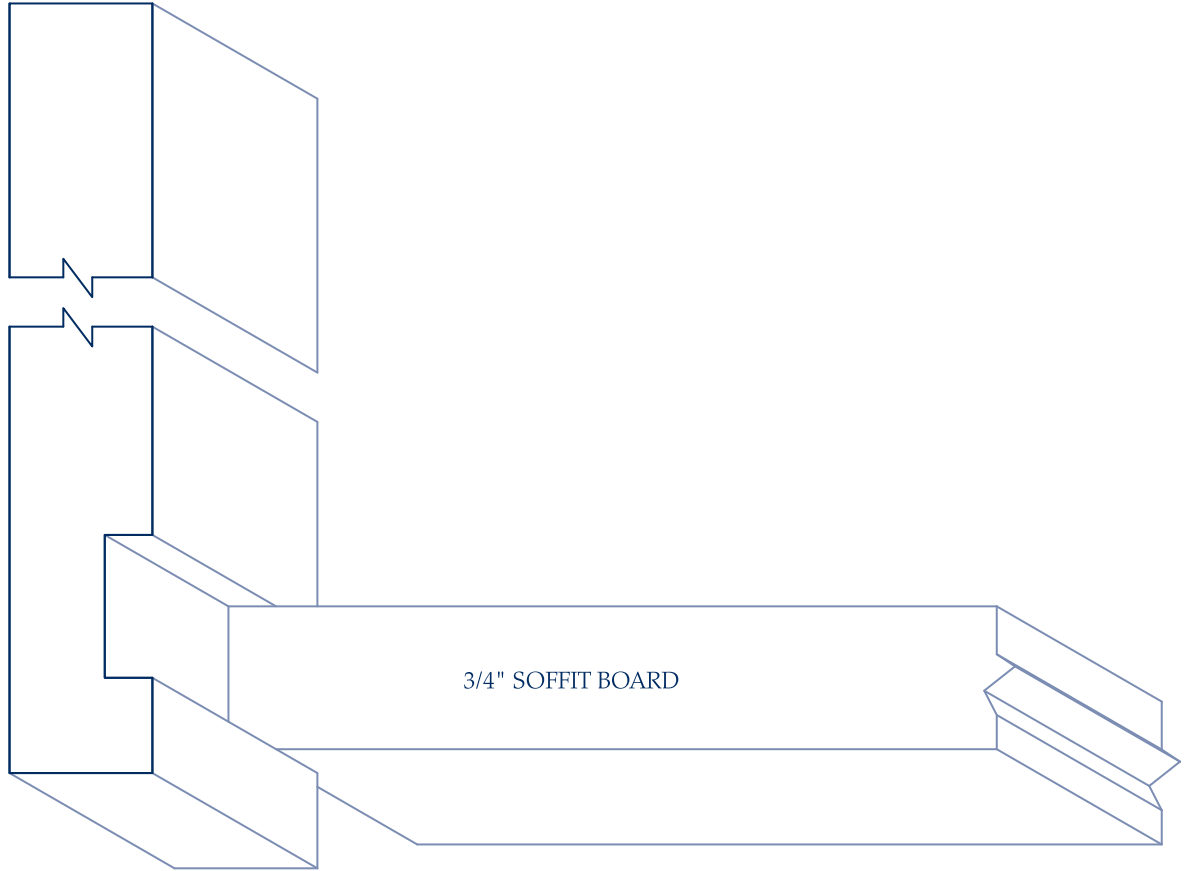

IL FAS1  
3/4 x 5 1/2

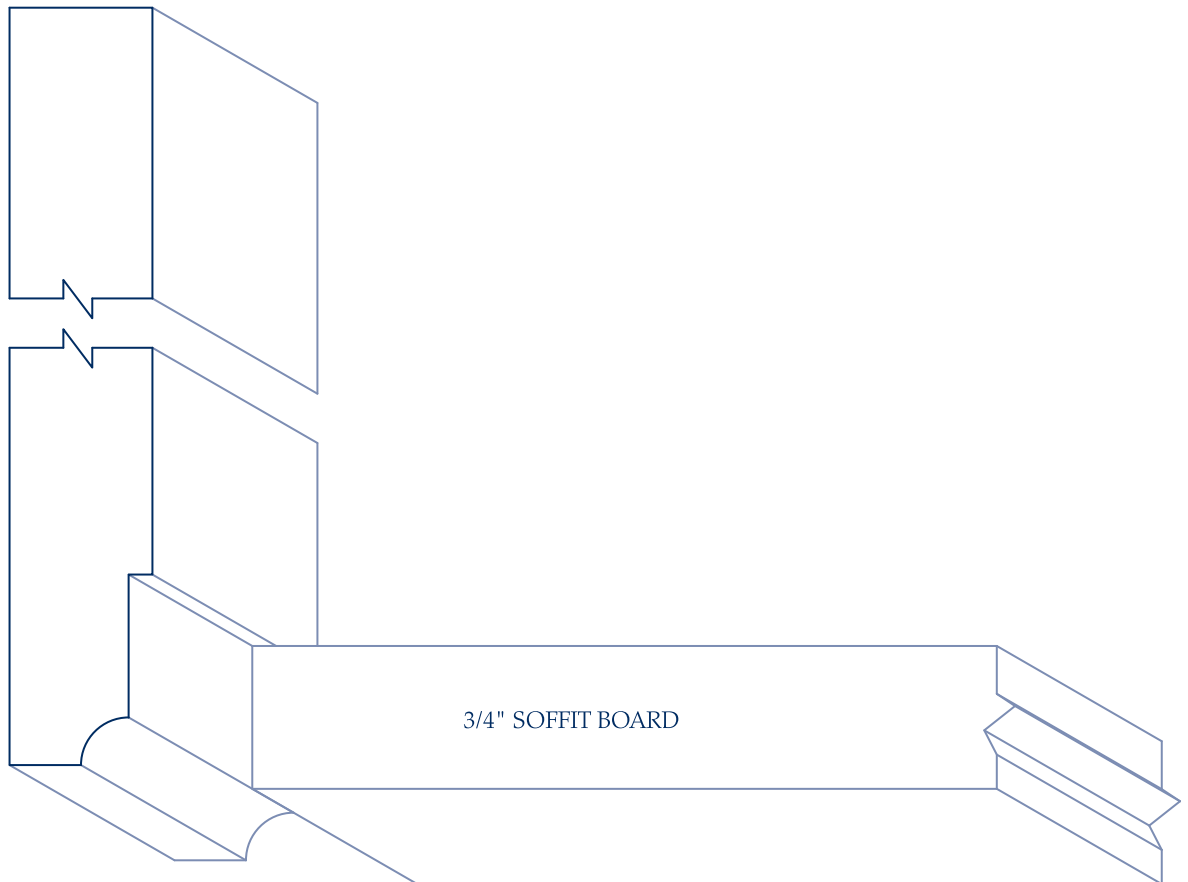

Profiles Shown 1:1

Greenwich, CT  
203.531.8050 914.939.2500

Bethel, CT  
203.748.5629

Newtown, CT  
203.364.0074

Stamford, CT  
203.348.3761

Westport, CT  
203.226.3321

Shrub Oak, NY  
914.245.5050



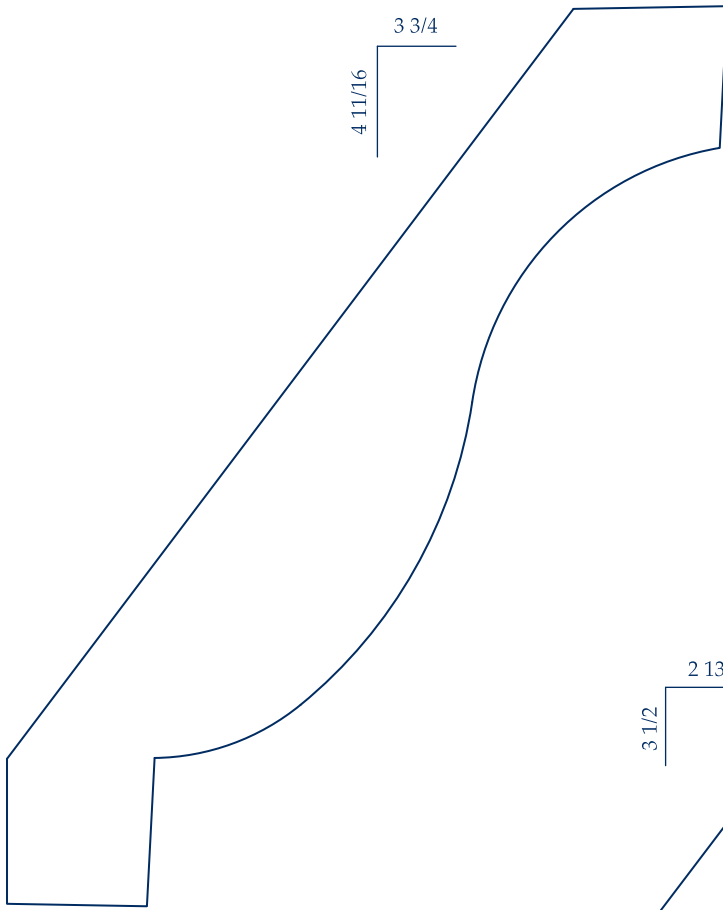

**IL 364**  
1 1/8 x 6

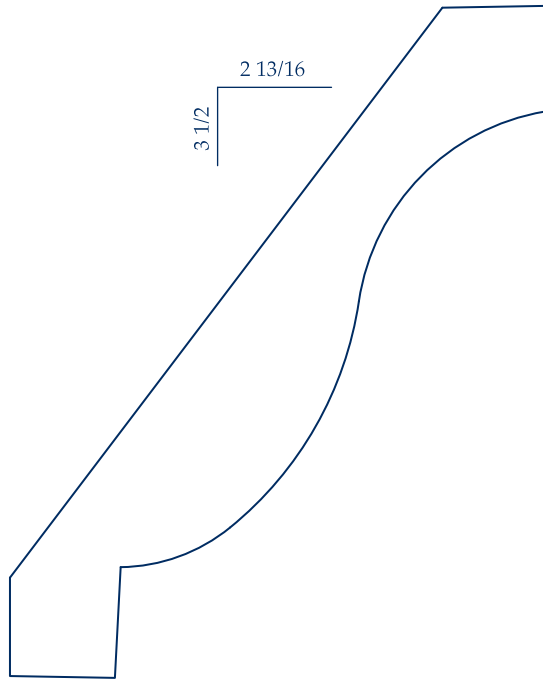

**IL 363**  
13/16 x 4 1/2

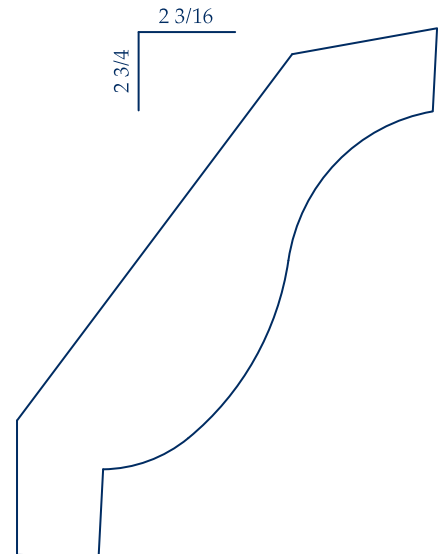

**IL 342**  
11/16 x 3 1/2



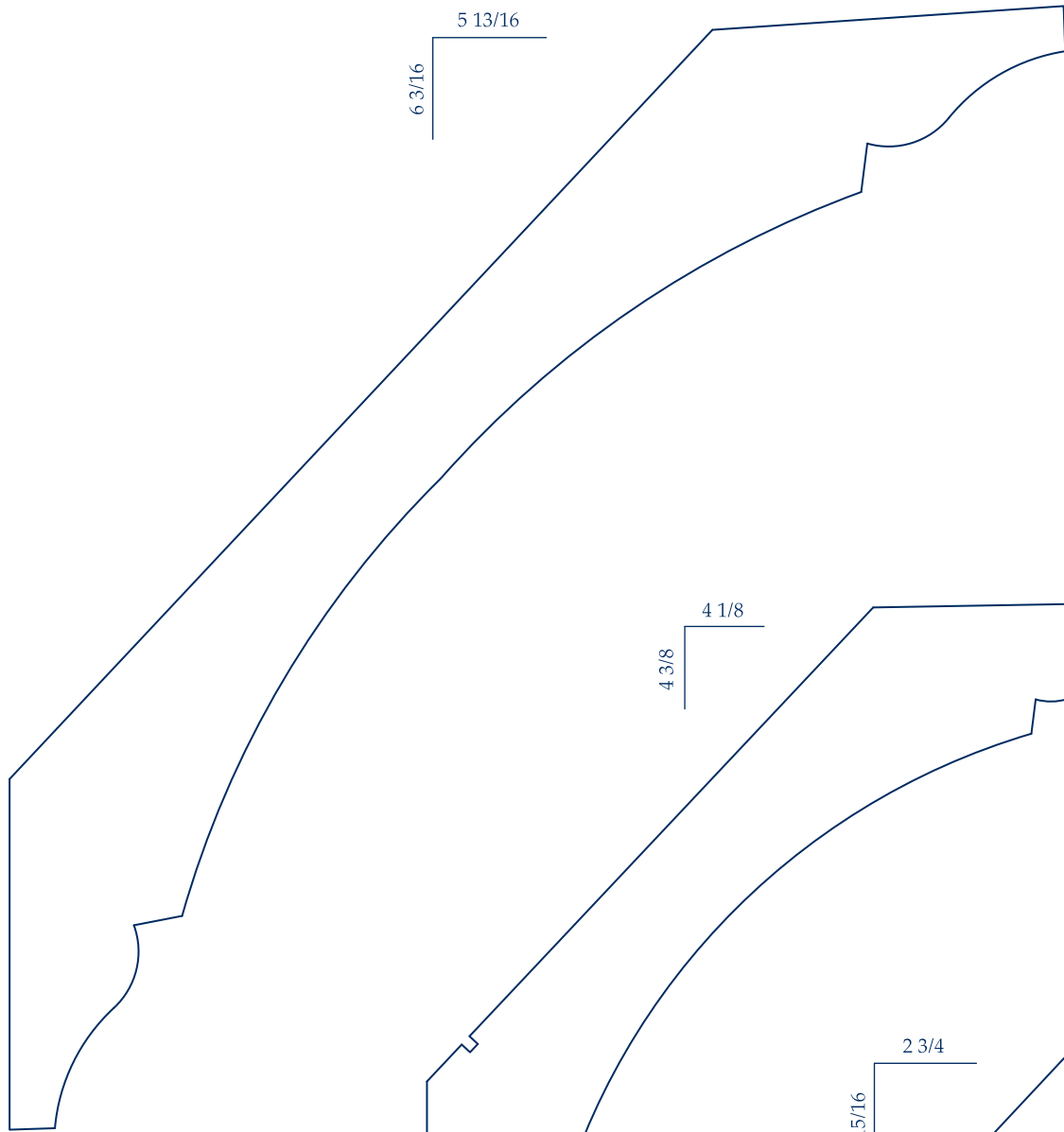

**IL 345**  
1 1/2 x 8 1/2

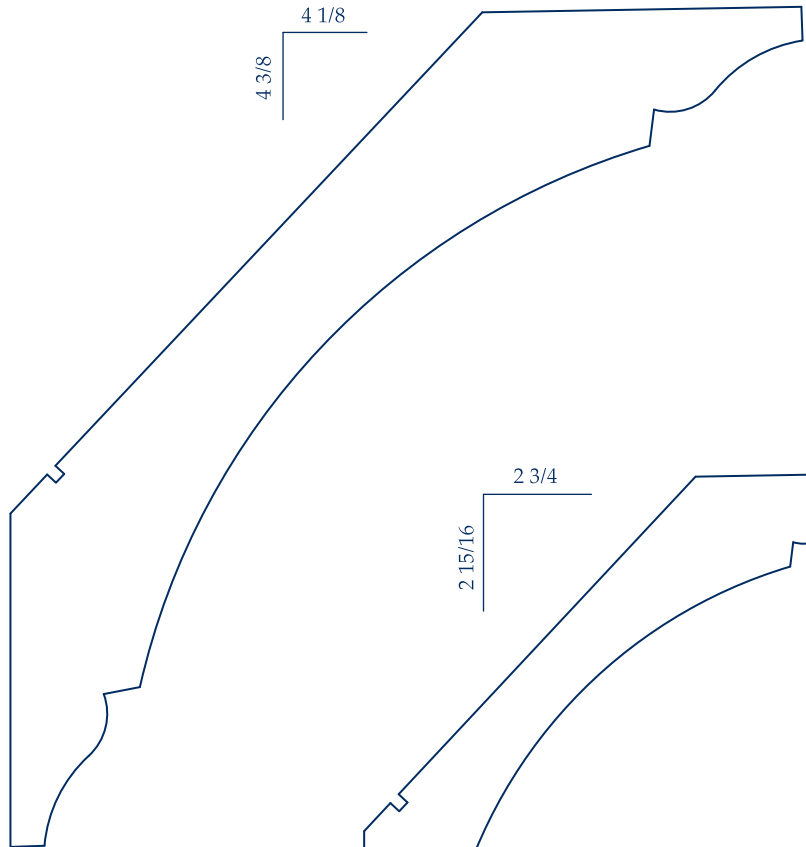

**IL 366**  
1 5/16 x 6

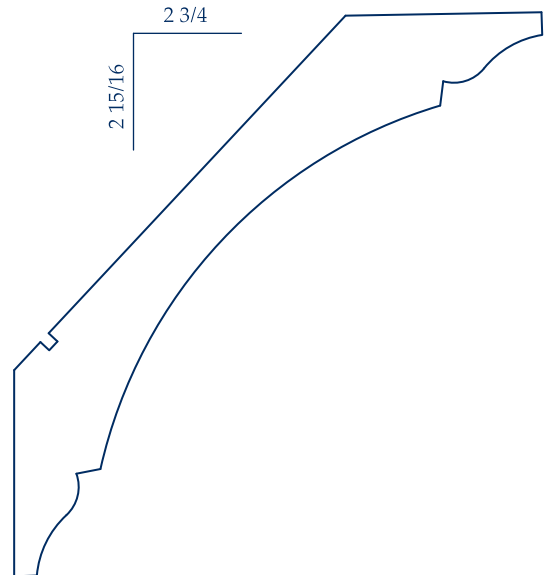

**IL 365**  
13/16 x 4

Profiles Shown 1:1

**Greenwich, CT**  
203.531.8050 914.939.2500

**Bethel, CT**  
203.748.5629

**Newtown, CT**  
203.364.0074

**Stamford, CT**  
203.348.3761

**Westport, CT**  
203.226.3321

**Shrub Oak, NY**  
914.245.5050



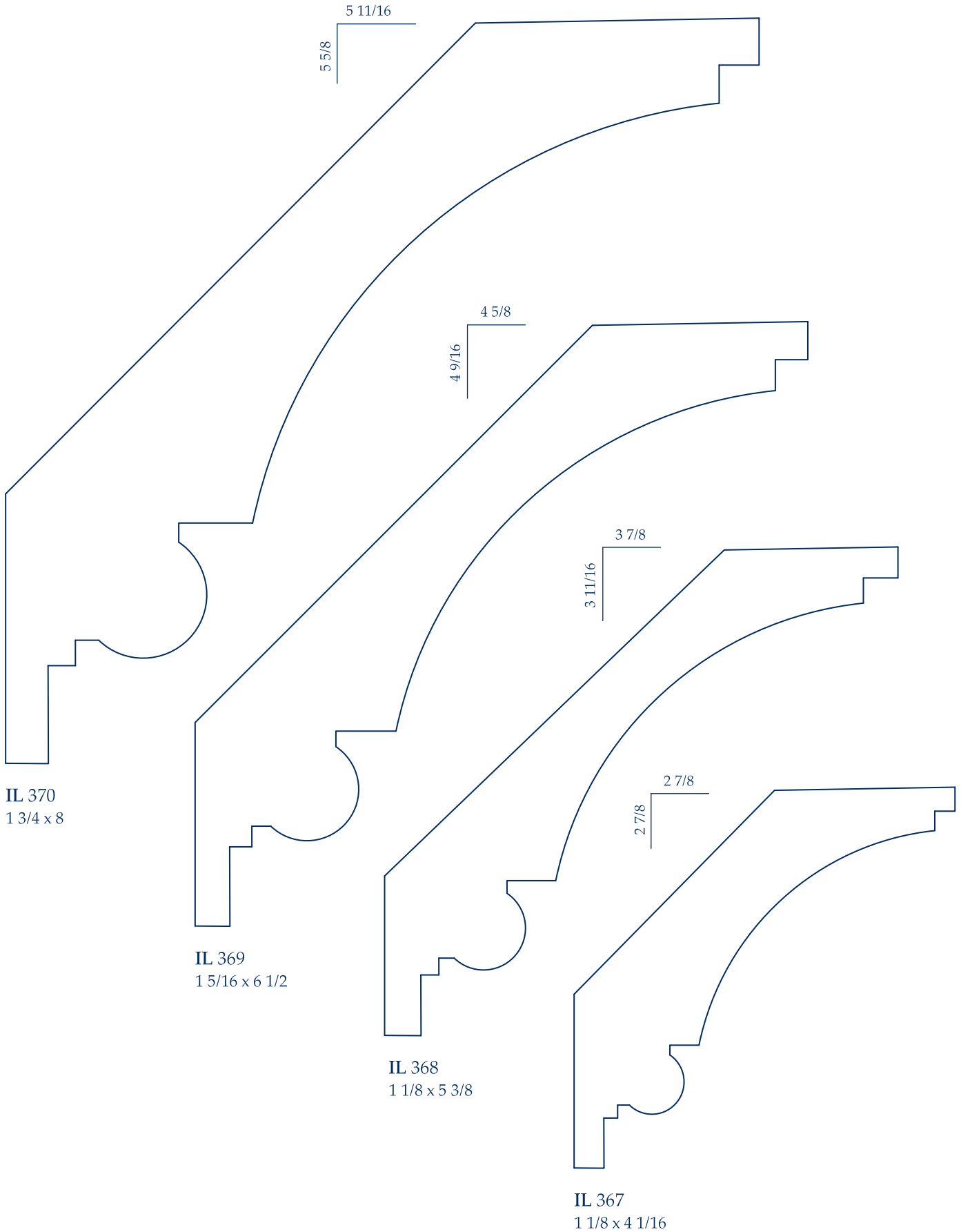

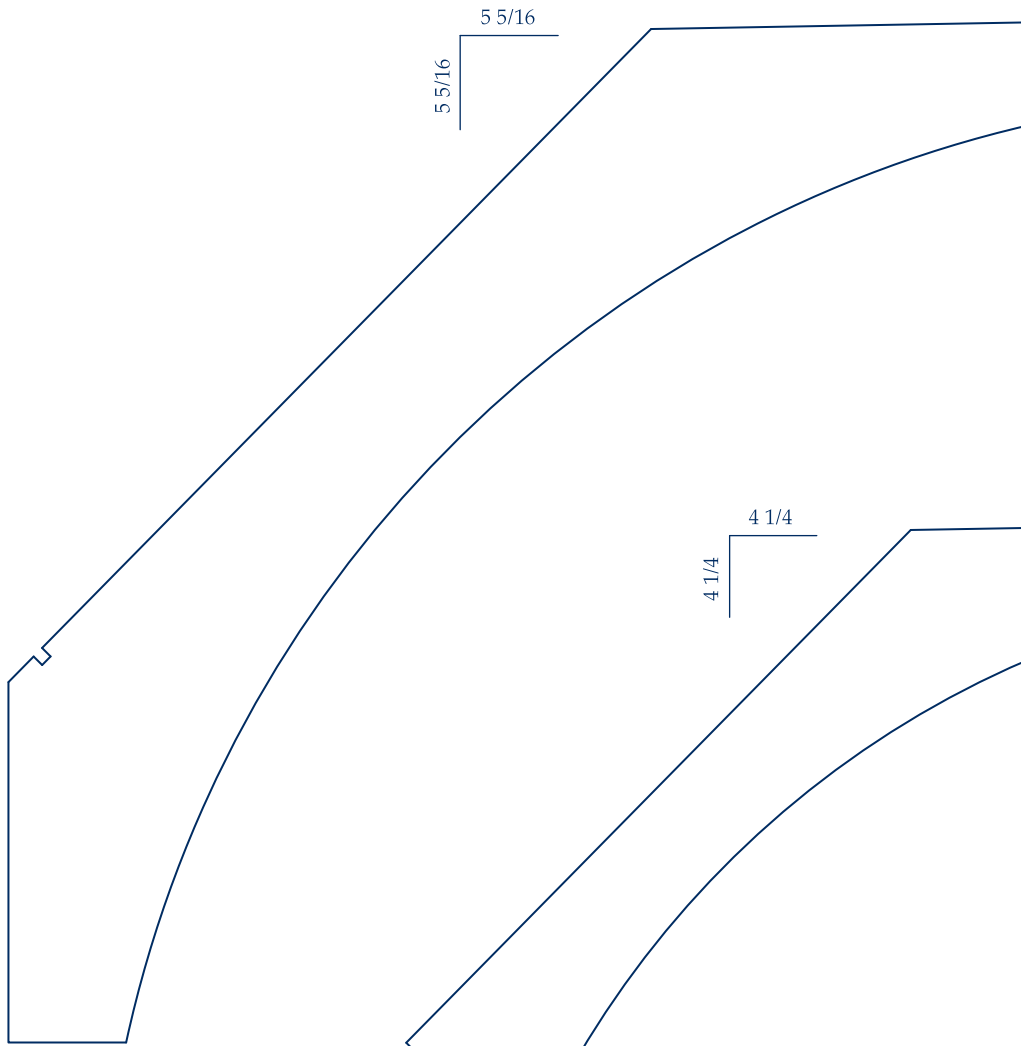

**IL 373**  
1 3/4 x 7 1/2

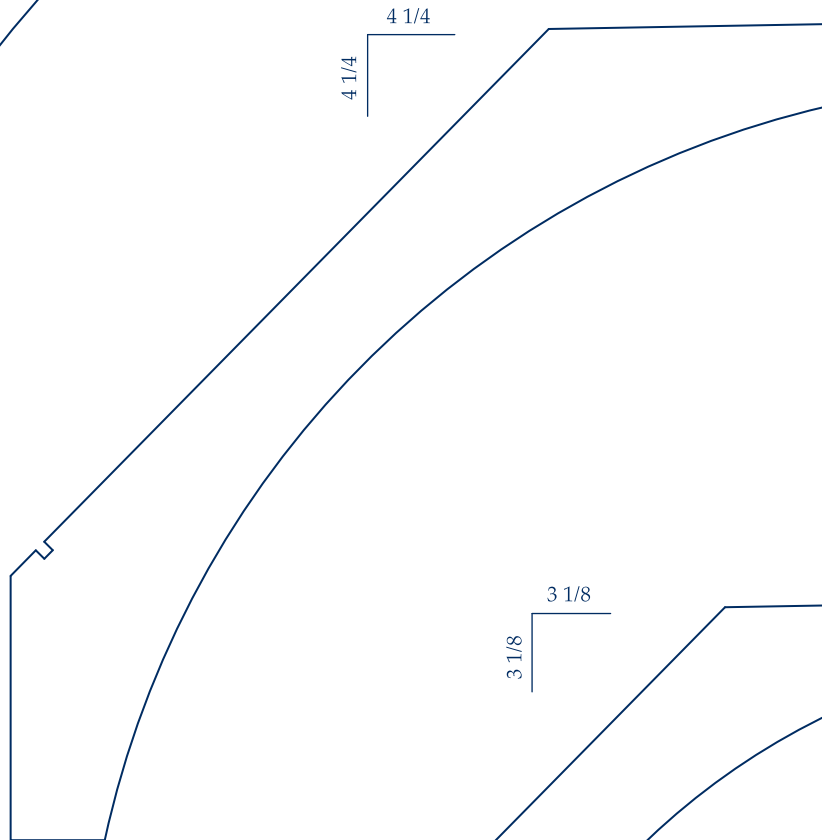

**IL 372**  
1 5/16 x 6

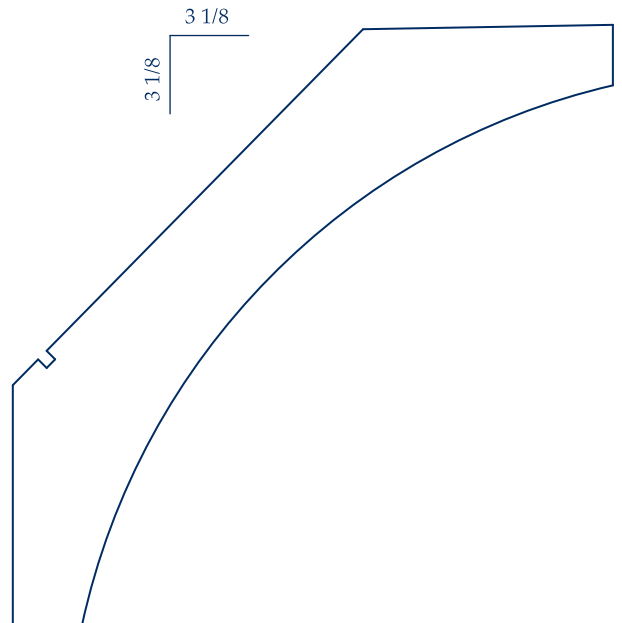

**IL 371**  
1 1/8 x 4 3/8

Profiles Shown 1:1

**Greenwich, CT**  
203.531.8050 914.939.2500

**Bethel, CT**  
203.748.5629

**Newtown, CT**  
203.364.0074

**Stamford, CT**  
203.348.3761

**Westport, CT**  
203.226.3321

**Shrub Oak, NY**  
914.245.5050



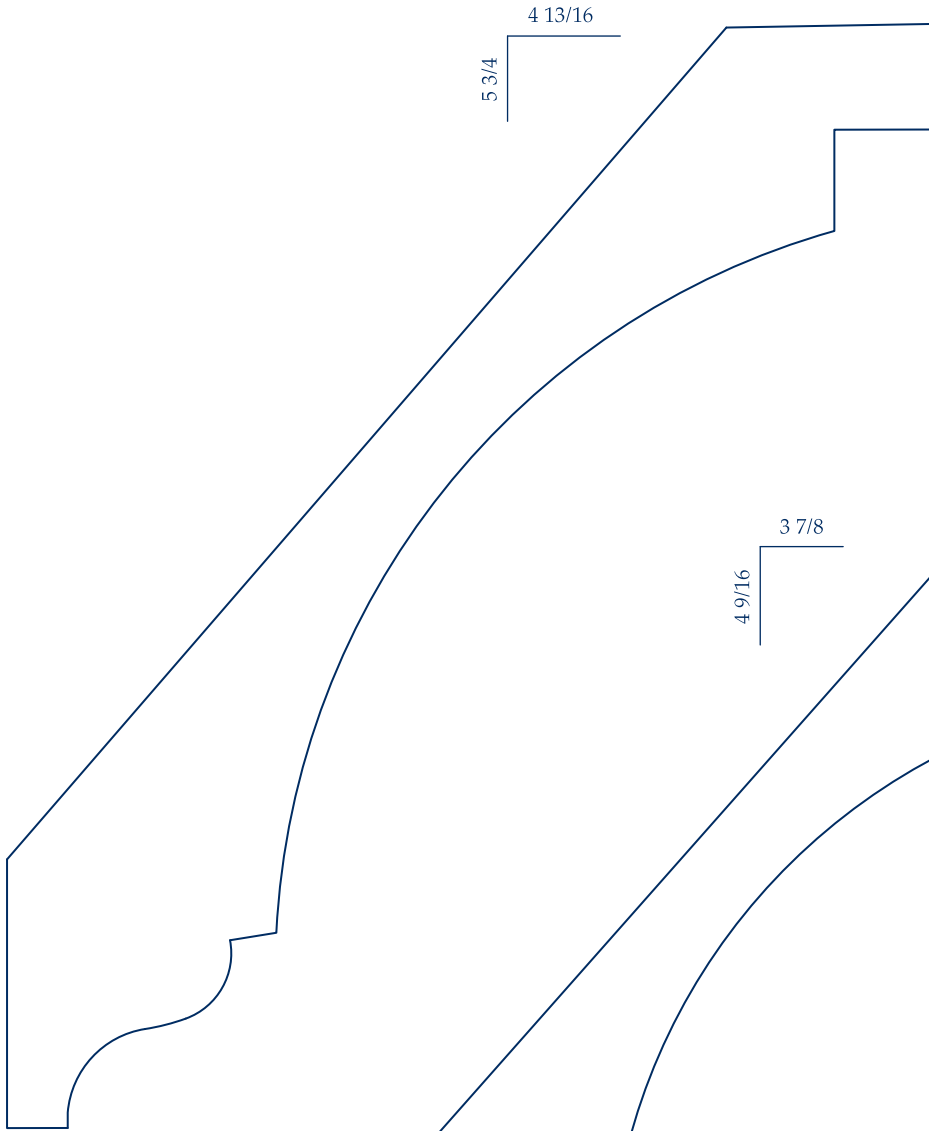

**IL 375**  
1 5/16 x 7 1/2

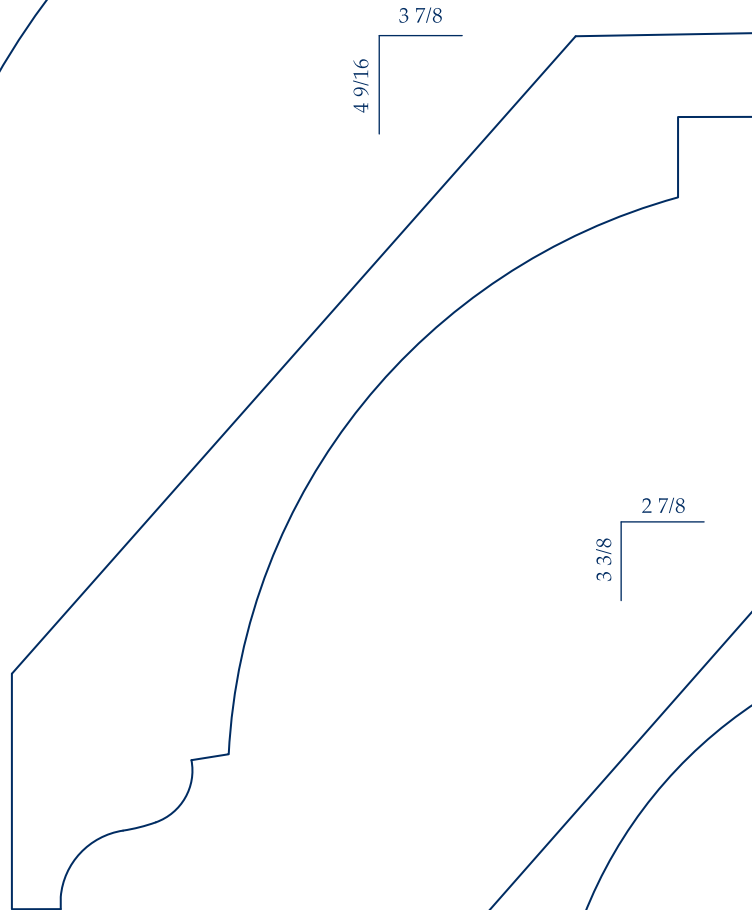

**IL 374**  
1 1/8 x 6

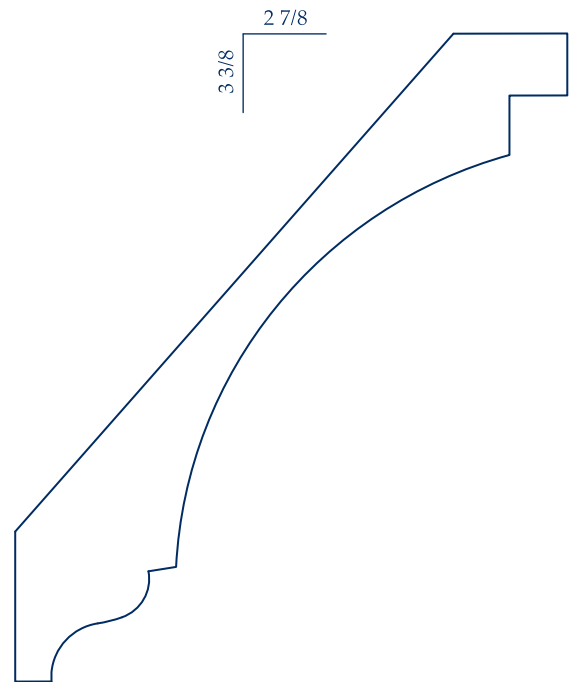

**IL 304**  
1 1/16 x 4 7/16

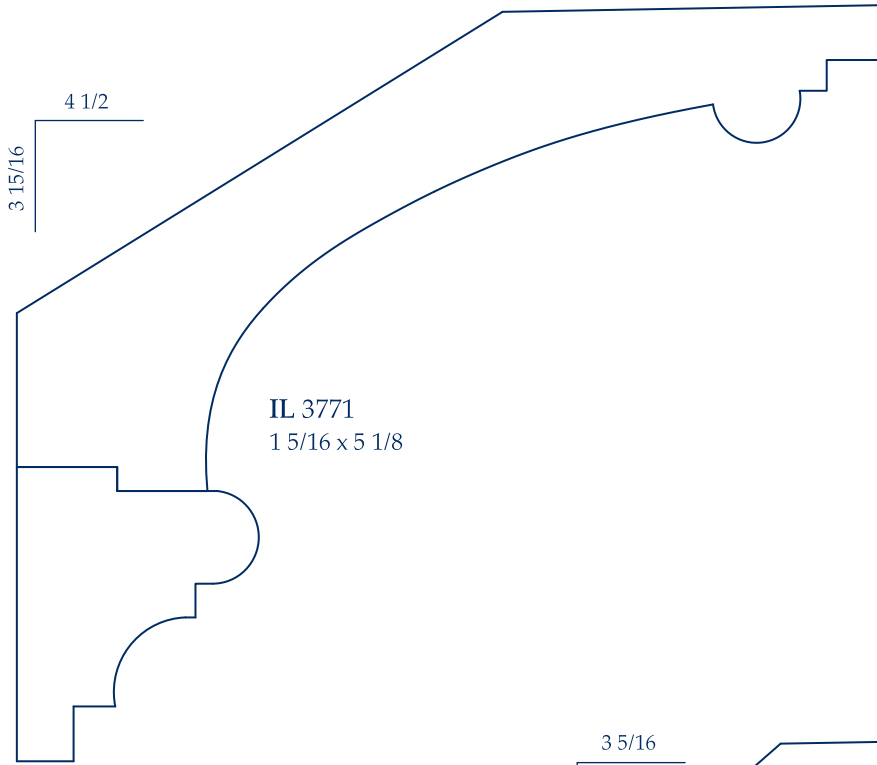

**IL 3771**  
1 5/16 x 5 1/8

**IL 3772**  
1 9/16 x 1/14

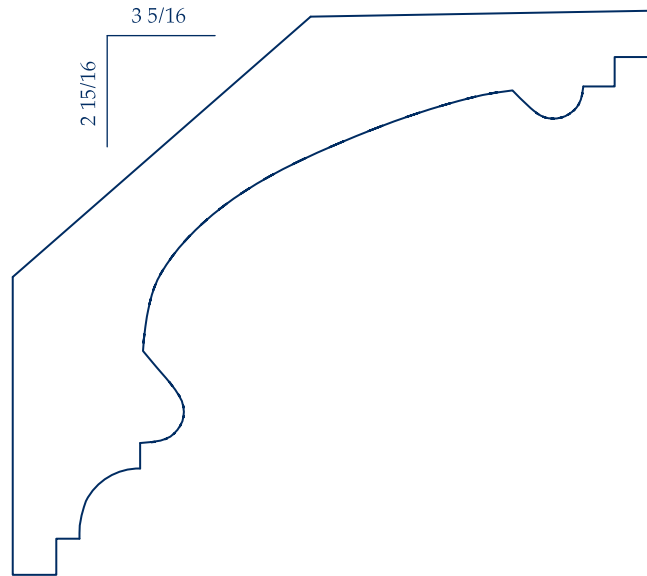

**IL 376**  
1 5/16 x 4 7/16

Profiles Shown 1:1

**Greenwich, CT**  
203.531.8050 914.939.2500

**Bethel, CT**  
203.748.5629

**Newtown, CT**  
203.364.0074

**Stamford, CT**  
203.348.3761

**Westport, CT**  
203.226.3321

**Shrub Oak, NY**  
914.245.5050



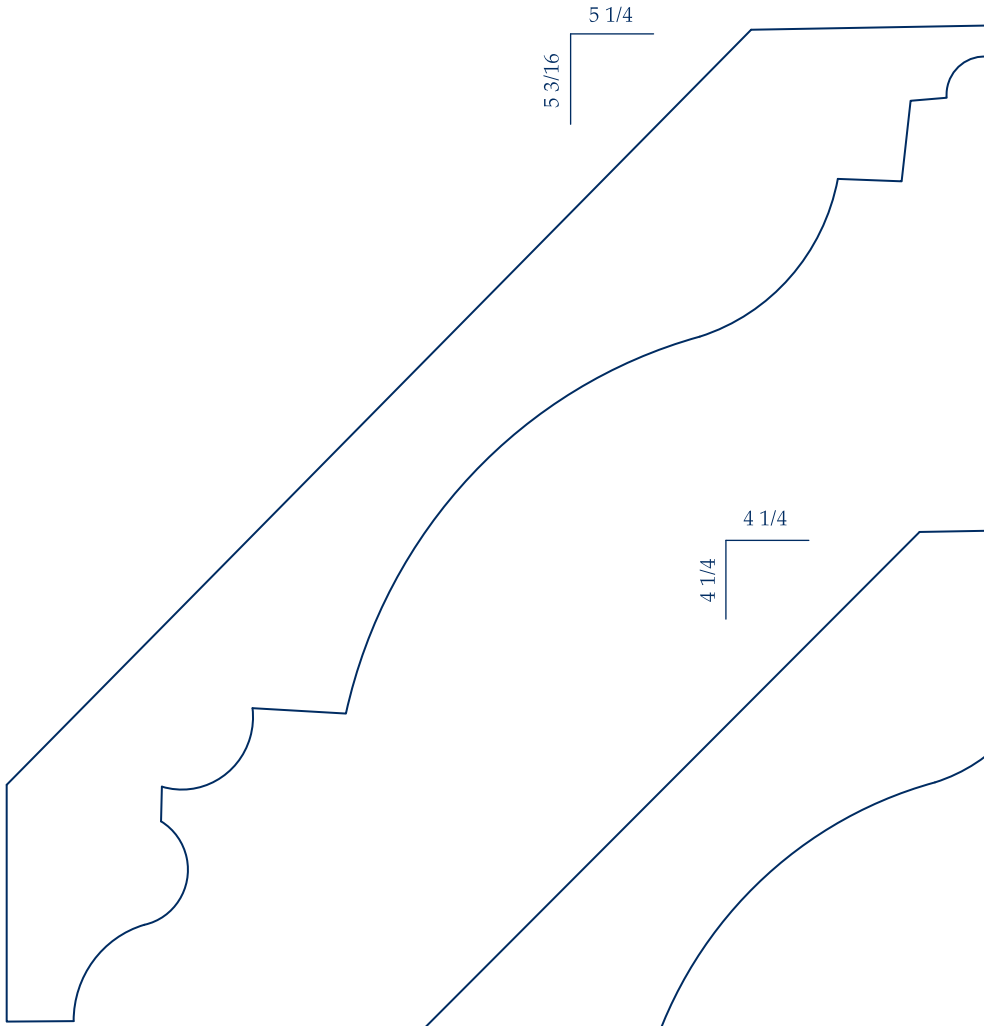

**IL 357**  
1 1/8 x 7 3/8

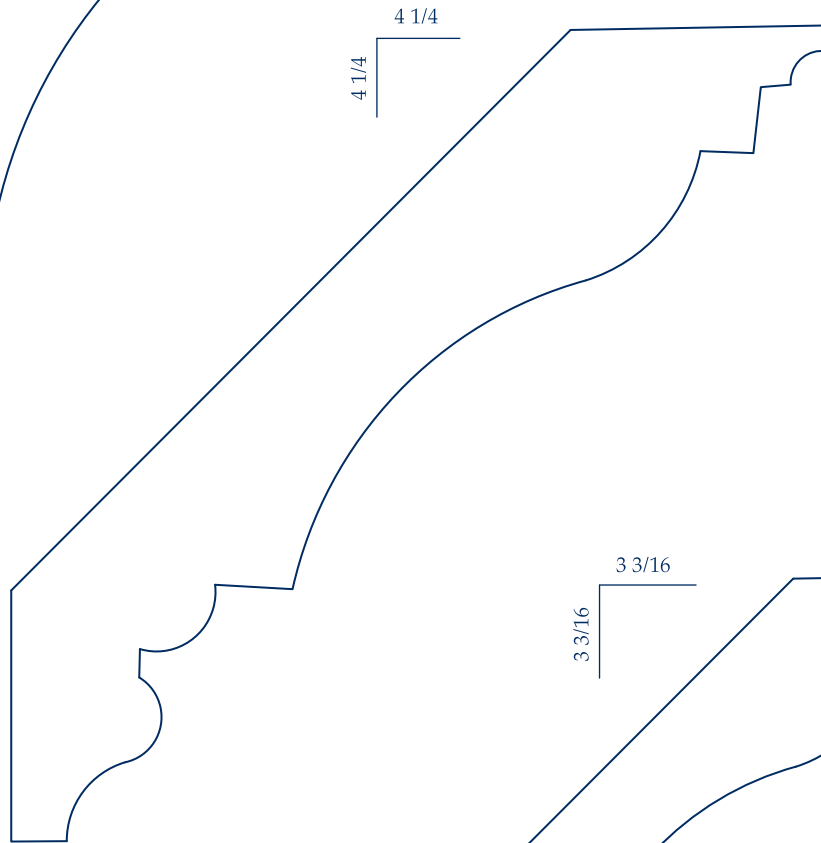

**IL 379**  
1 1/8 x 6

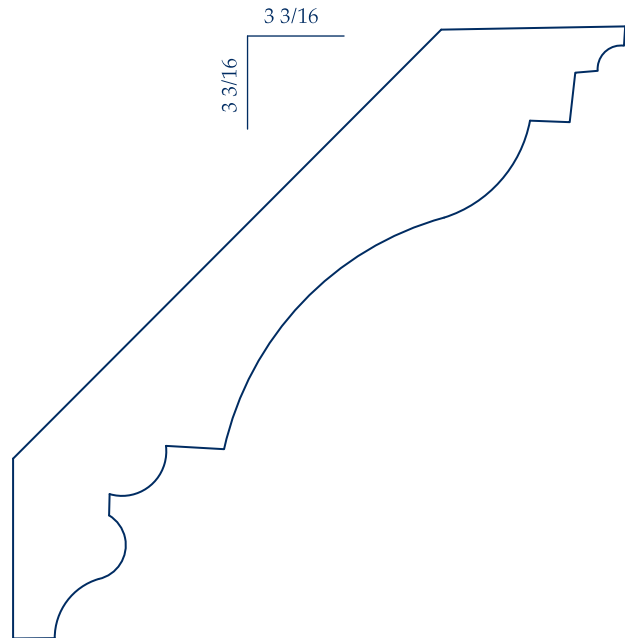

**IL 378**  
13/16 x 4 1/2

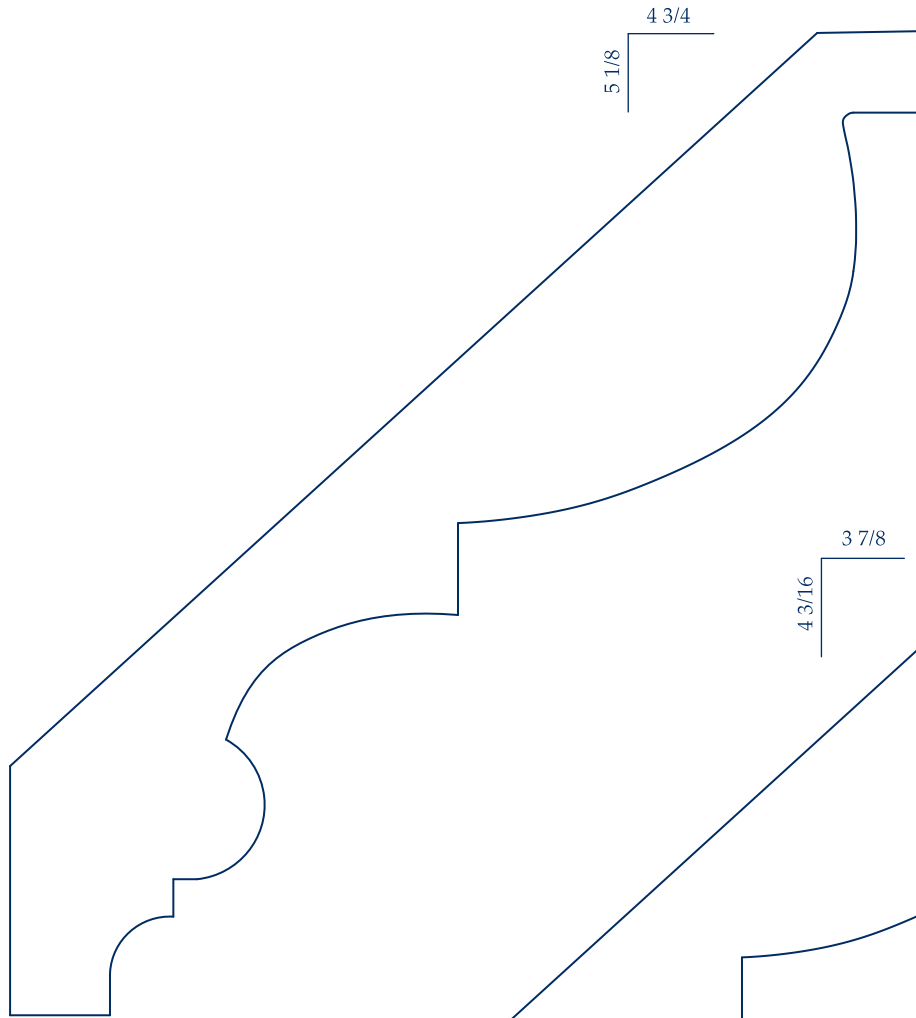

**IL 382**  
1 5/16 x 7

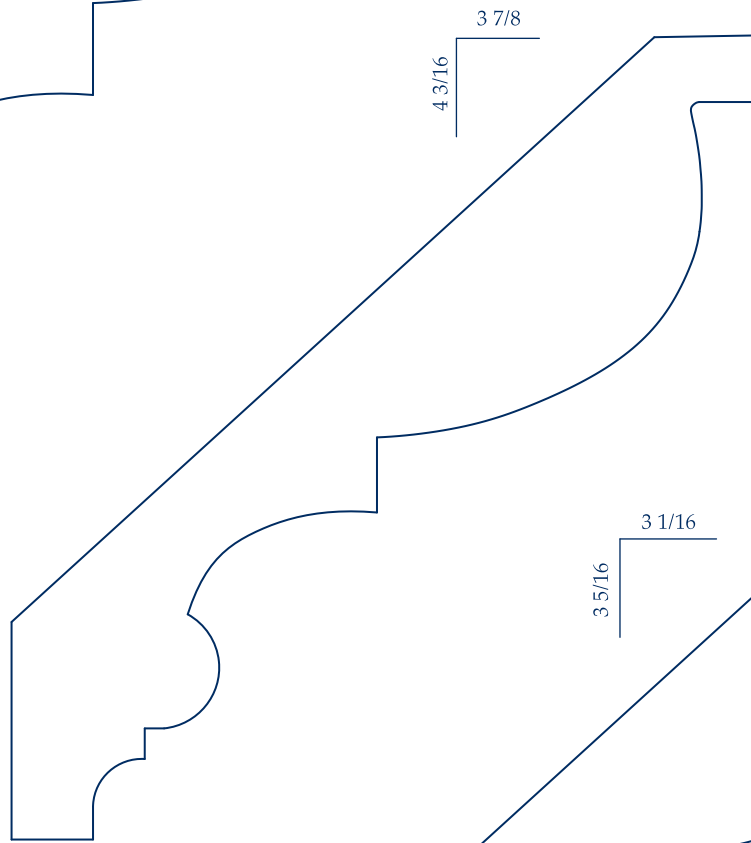

**IL 381**  
1 1/8 x 5 11/16

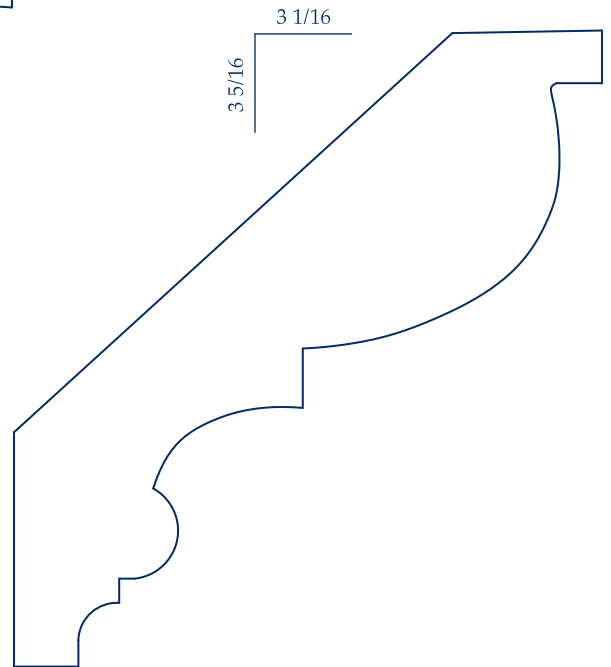

**IL 380**  
1 1/8 x 4 1/2

Profiles Shown 1:1

**Greenwich, CT**  
203.531.8050 914.939.2500

**Bethel, CT**  
203.748.5629

**Newtown, CT**  
203.364.0074

**Stamford, CT**  
203.348.3761

**Westport, CT**  
203.226.3321

**Shrub Oak, NY**  
914.245.5050



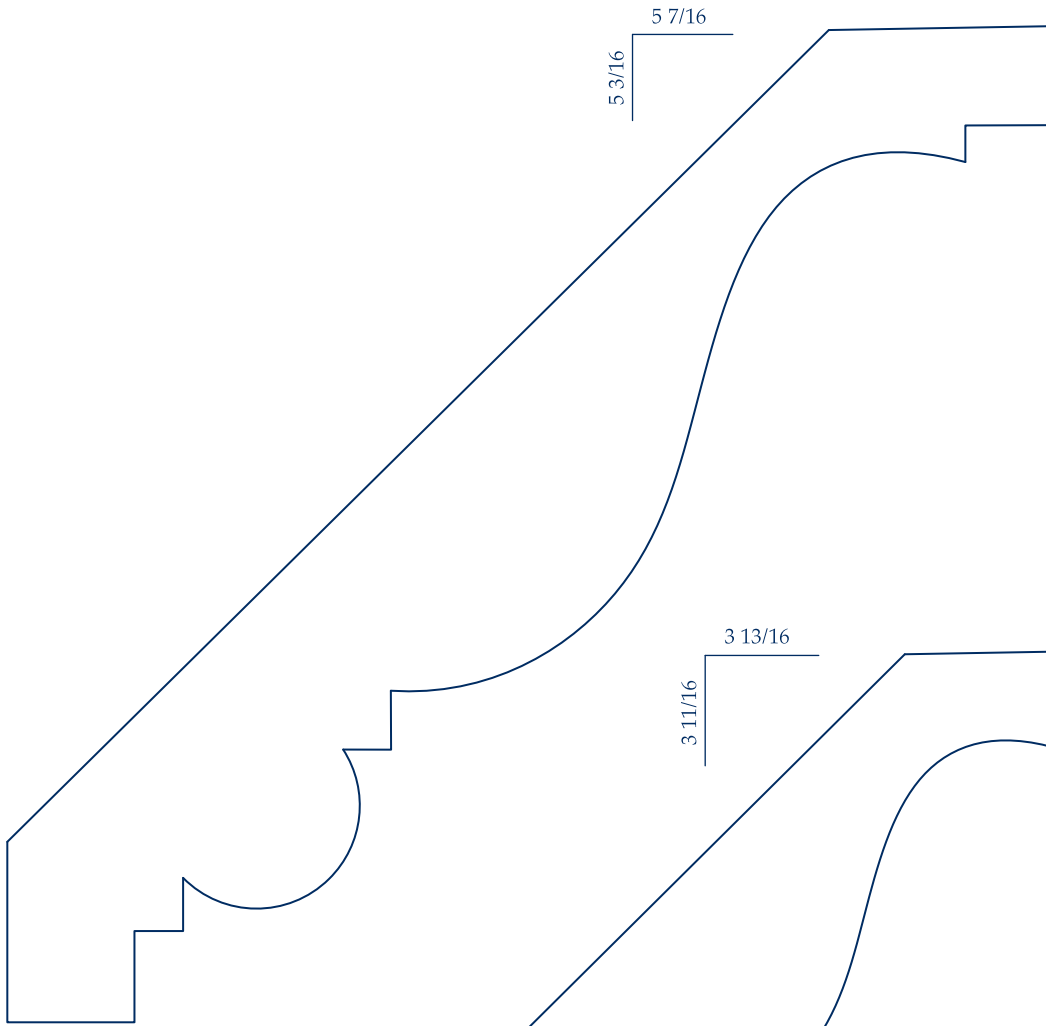

**IL 385**  
1 5/16 x 7 1/2

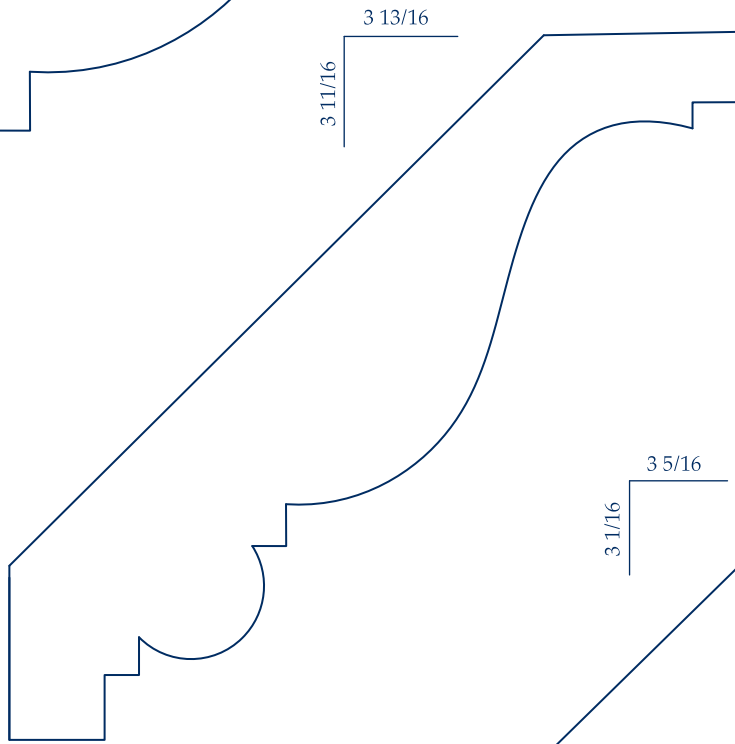

**IL 384**  
1 1/8 x 5 5/16

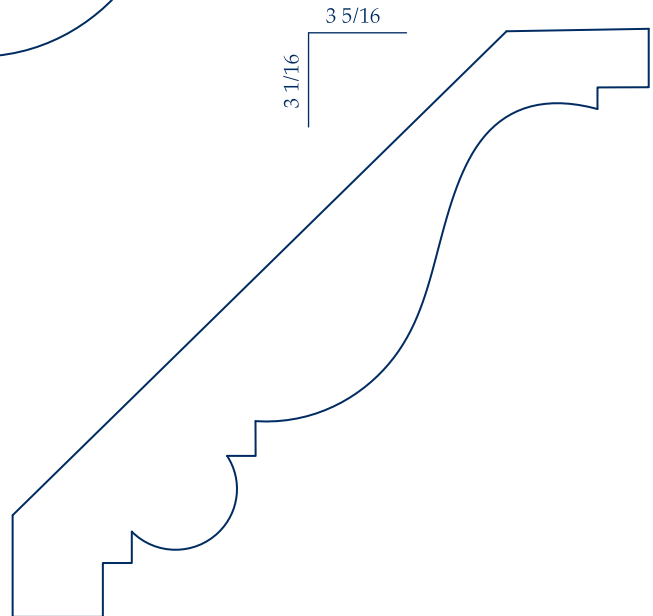

**IL 383**  
13/16 x 4 1/2





**IL 387**  
1 1/8 x 7 1/2

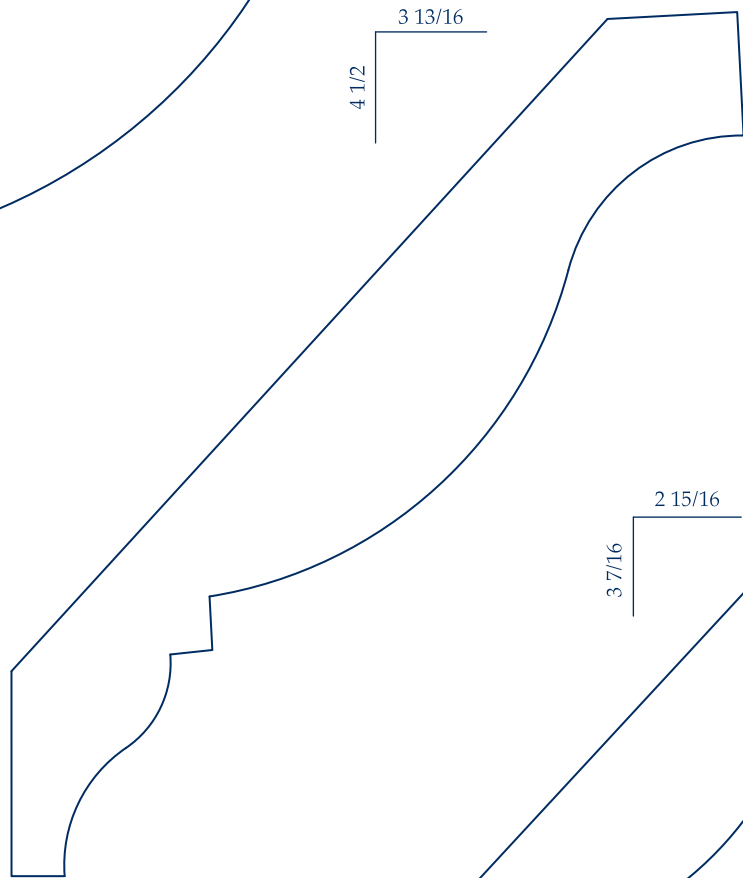

**IL 326**  
1 x 5 7/8



**IL 386**  
13/16 x 4 1/2

Profiles Shown 1:1

**Greenwich, CT**  
203.531.8050 914.939.2500

**Bethel, CT**  
203.748.5629

**Newtown, CT**  
203.364.0074

**Stamford, CT**  
203.348.3761

**Westport, CT**  
203.226.3321

**Shrub Oak, NY**  
914.245.5050



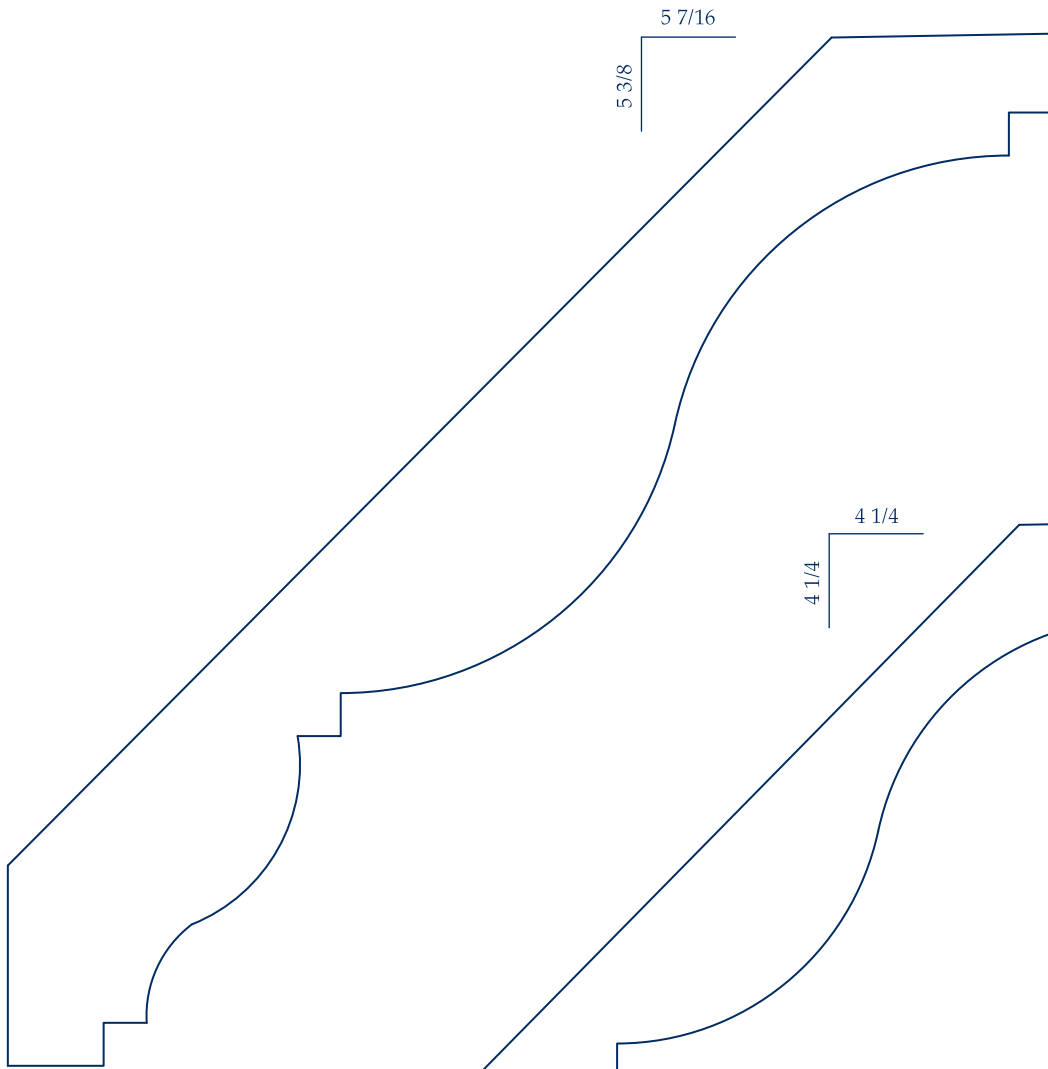

**IL 390**  
1 1/8 x 7 11/16

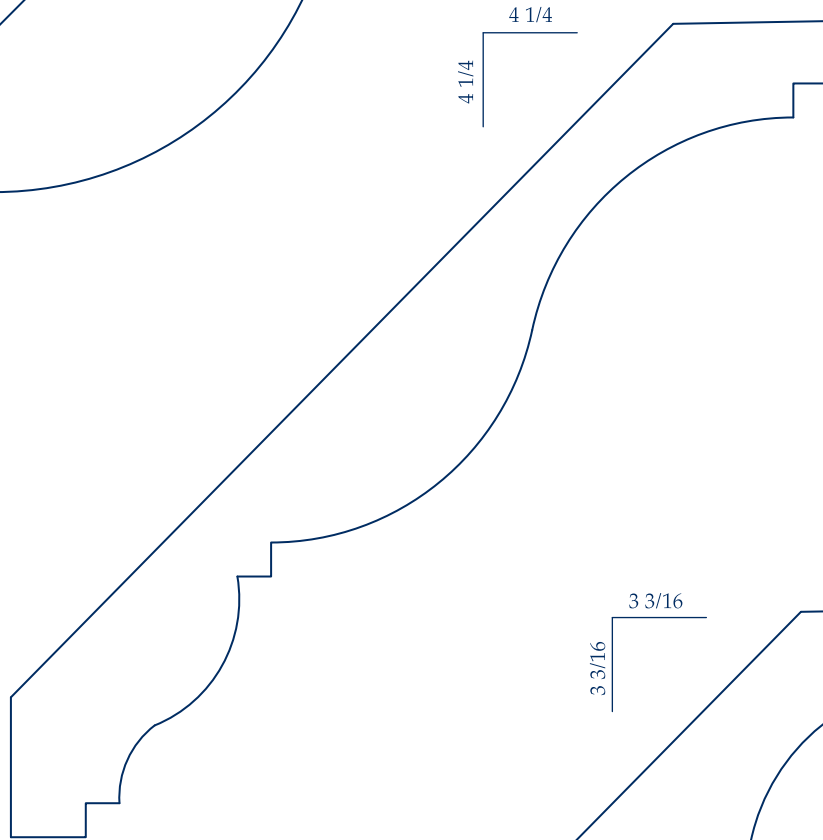

**IL 389**  
13/16 x 6

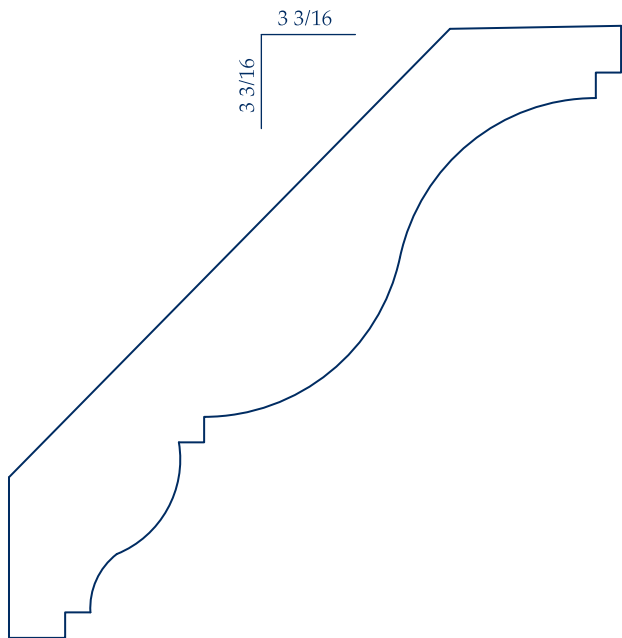

**IL 388**  
13/16 x 4 1/2

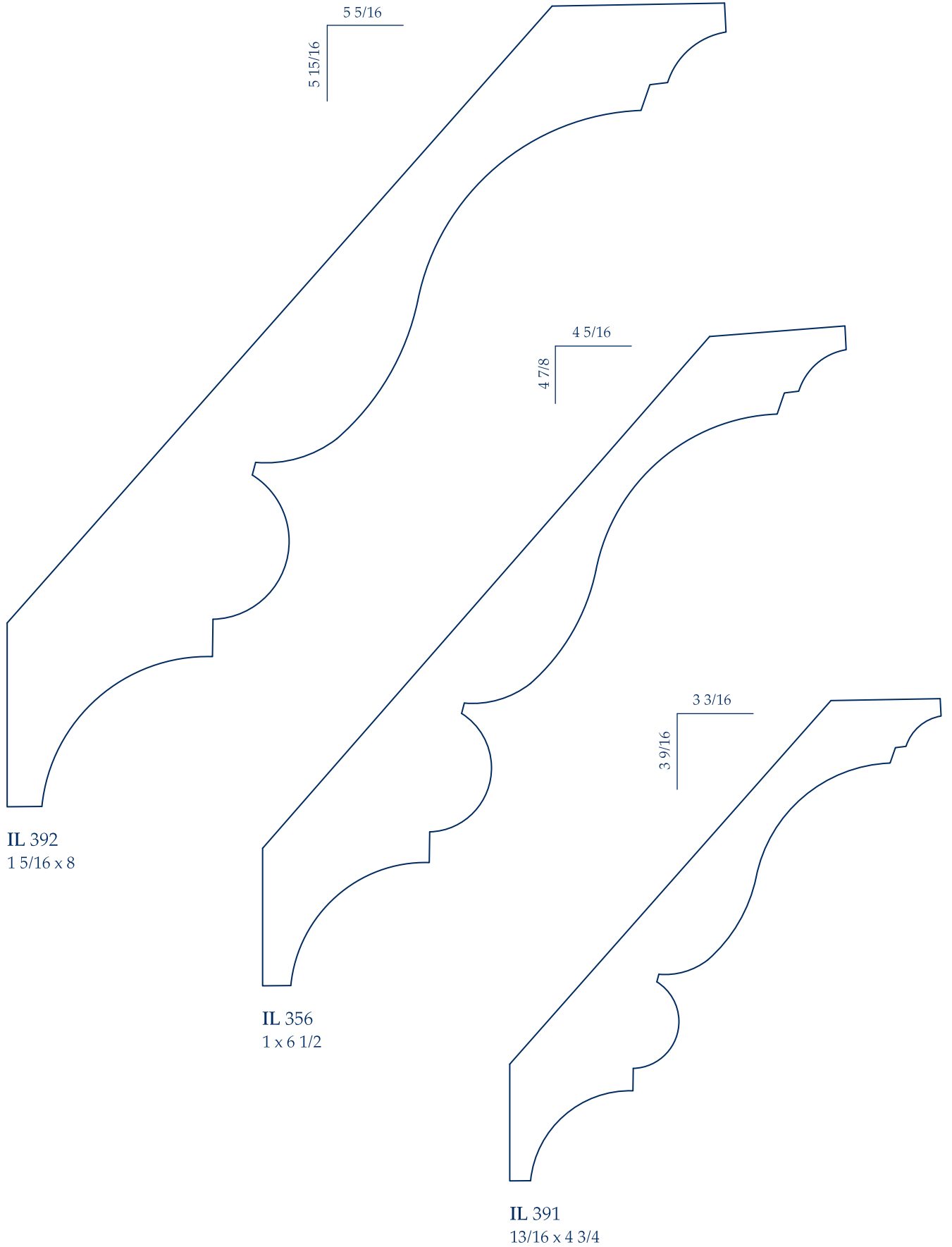

**IL 392**  
1 5/16 x 8

**IL 356**  
1 x 6 1/2

**IL 391**  
13/16 x 4 3/4

Profiles Shown 1:1

**Greenwich, CT**  
203.531.8050 914.939.2500

**Bethel, CT**  
203.748.5629

**Newtown, CT**  
203.364.0074

**Stamford, CT**  
203.348.3761

**Westport, CT**  
203.226.3321

**Shrub Oak, NY**  
914.245.5050



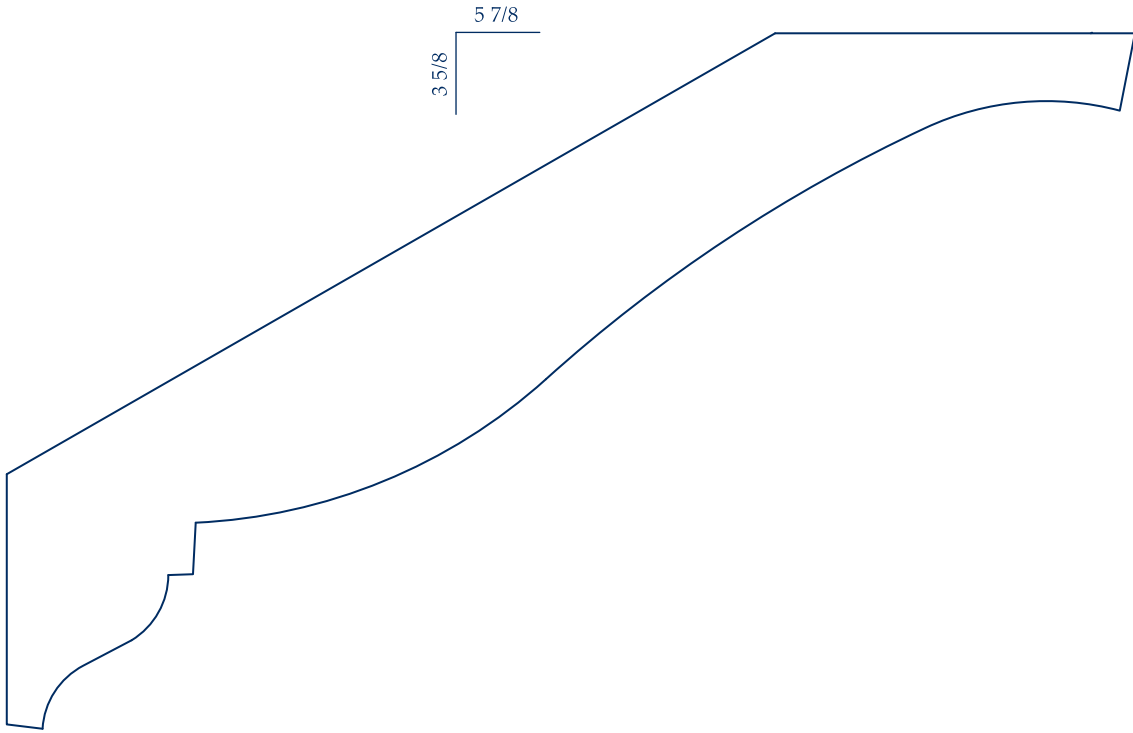

IL 327  
1 1/4 x 6 7/8

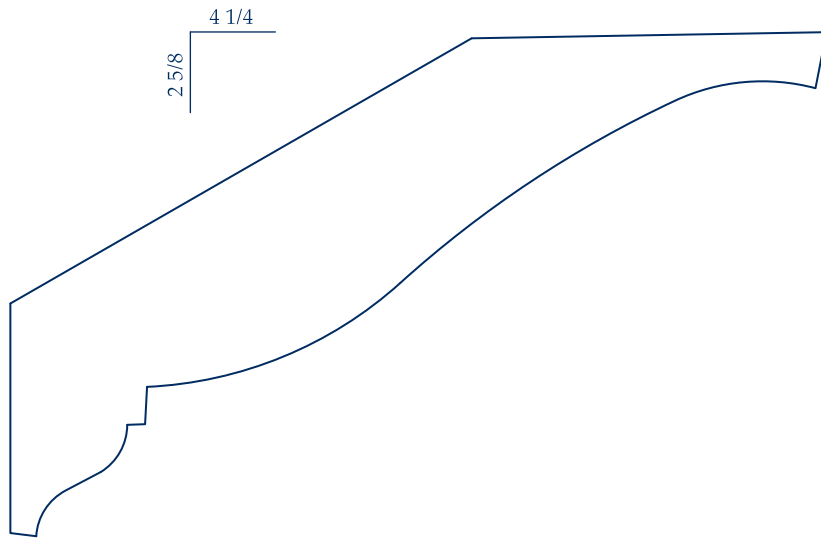

IL 393  
1 1/8 x 5





**IL 619**  
7/8 x 1 1/8

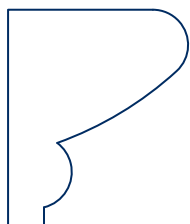

**IL 621**  
15/16 x 1 1/8



**IL 620**  
9/16 x 1 1/4



**IL 616**  
7/8 x 1 1/4



**IL 615**  
11/16 x 1 3/4

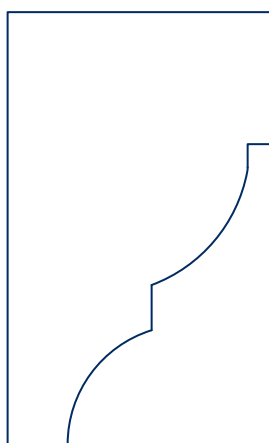

**IL 610**  
1 3/8 x 2 1/4

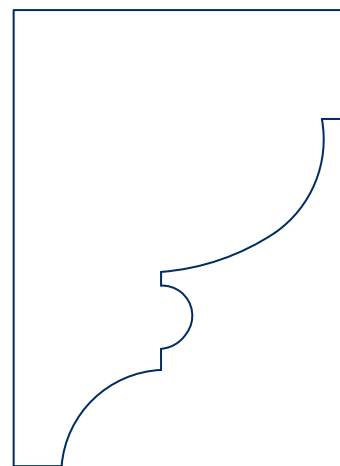

**IL 634**  
1 3/4 x 2 3/8

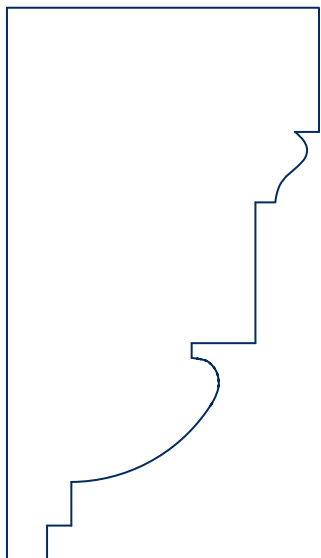

IL 636  
1 5/8 x 2 7/8

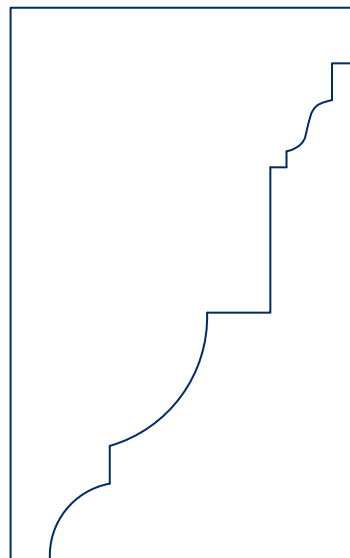

IL 635  
1 13/16 x 2 7/8

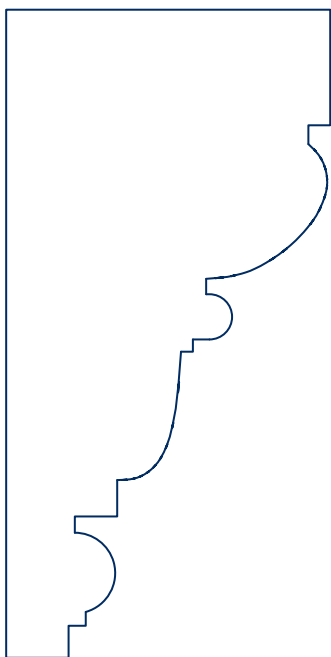

IL 637  
1 11/16 x 3 3/8

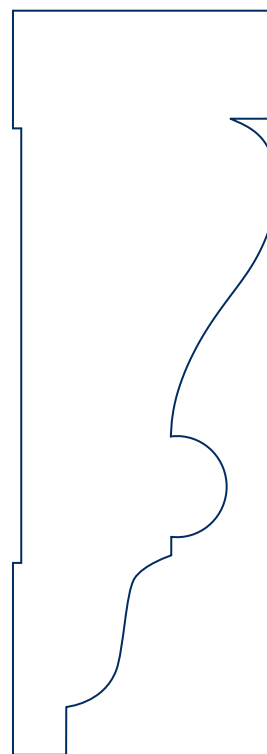

IL 638  
1 3/8 x 3 7/8

Profiles Shown 1:1

Greenwich, CT  
203.531.8050 914.939.2500

Bethel, CT  
203.748.5629

Newtown, CT  
203.364.0074

Stamford, CT  
203.348.3761

Westport, CT  
203.226.3321

Shrub Oak, NY  
914.245.5050



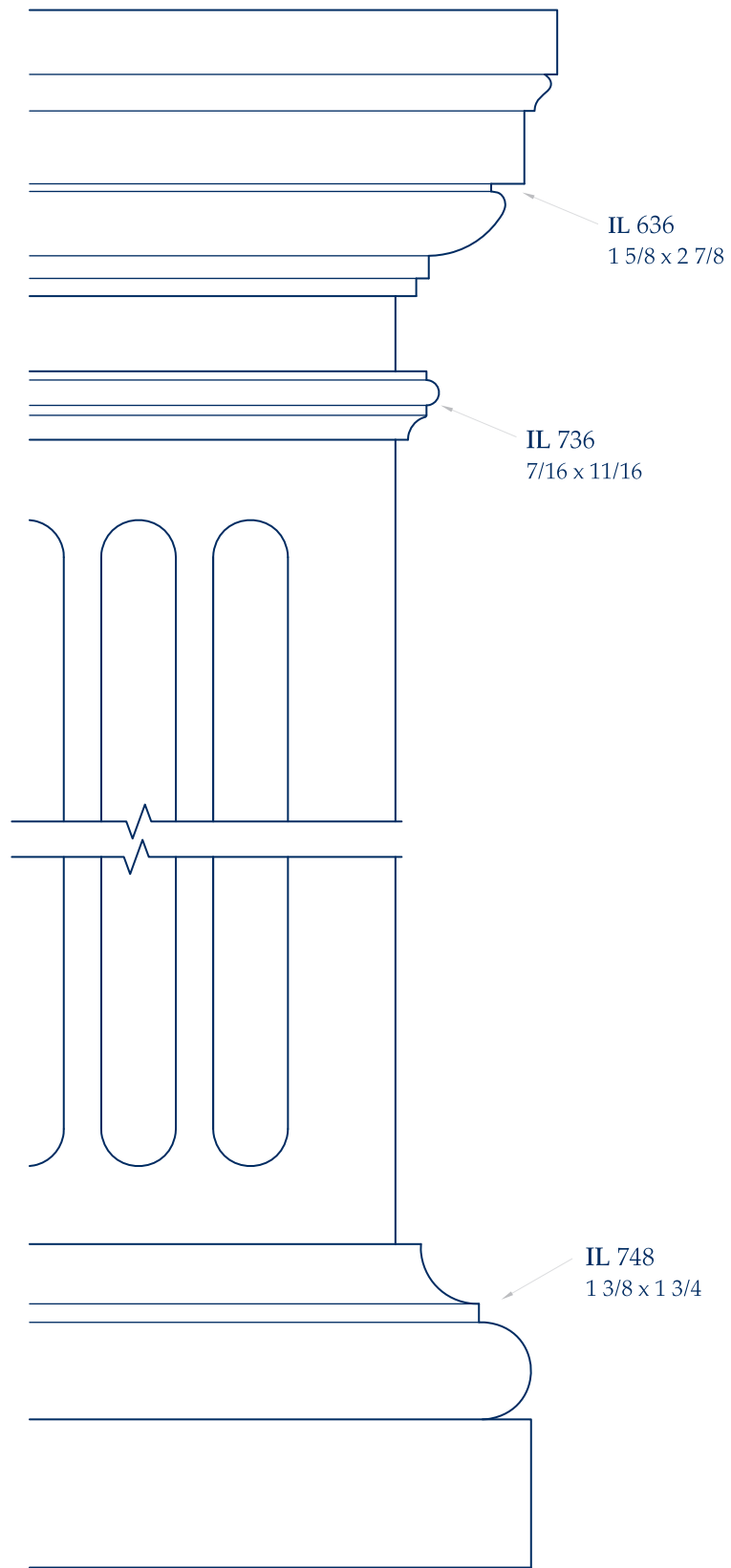





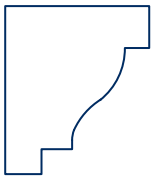

**IL 631**  
3/4 x 7/8



**IL 632**  
3/4 x 1 1/8

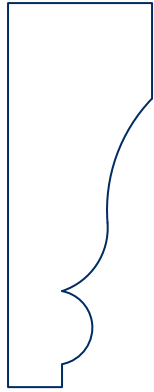

**IL 628**  
3/4 x 2

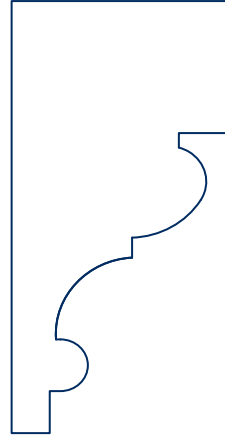

**IL 627**  
1 1/8 x 2 1/4

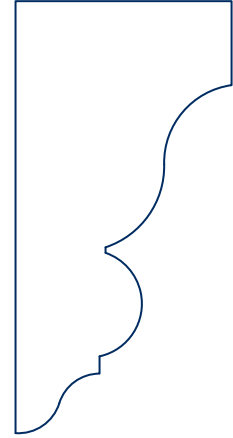

**IL 626**  
1 1/8 x 2 1/4

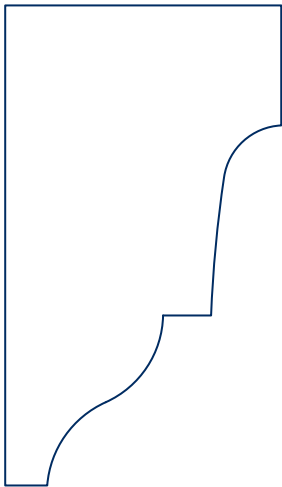

**IL 623**  
1 7/16 x 2 1/2

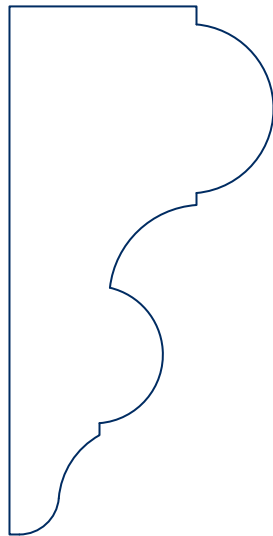

**IL 624**  
1 3/8 x 2 3/4

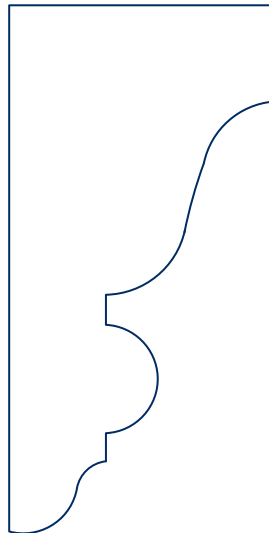

**IL 633**  
1 3/8 x 2 3/4

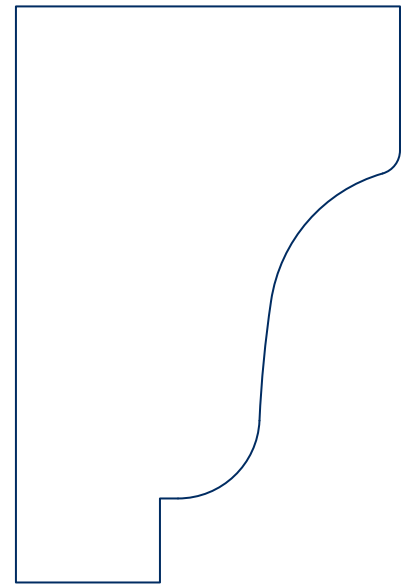

**IL 622**  
2 x 3





>1" - 1"



**IL 736**  
7/16 x 11/16



**IL 731**  
1/2 x 3/4



**IL 737**  
7/16 x 3/4



**IL 730**  
1/2 x 3/4



**IL 738**  
3/4 x 1



**IL 739**  
7/16 x 1



**IL 733**  
9/16 x 1 1/8



**IL 728**  
3/8 x 1 1/8



**IL 740**  
3/8 x 1 1/8



**IL 741**  
3/4 x 1 1/8



**IL 715**  
11/16 x 1 1/4



**IL 720**  
3/8 x 1 1/4

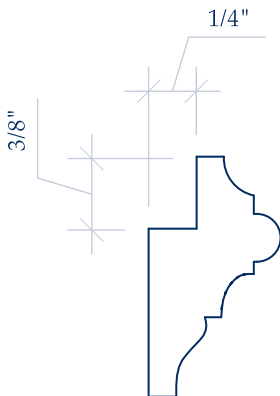

**IL 742**  
11/16 x 1 1/4



**IL 744**  
3/8 x 1 5/16

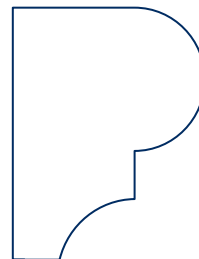

**IL 743**  
1 x 1 5/16



**IL 745**  
3/4 x 1 3/8



IL 716  
1/2 x 1 3/8



IL 719  
9/16 x 1 3/8



IL 718  
7/16 x 1 3/8

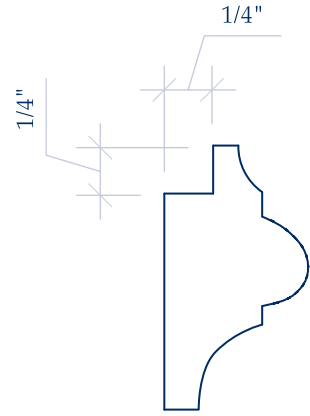

IL 746  
3/4 x 1 3/8

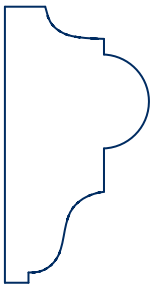

IL 747  
3/4 x 1 7/16



IL 717  
7/16 x 1 1/2



IL 712  
11/16 x 1 1/2

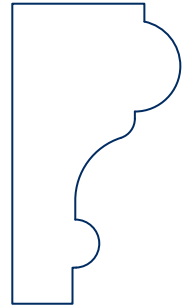

IL 713  
7/8 x 1 9/16



IL 711  
11/16 x 1 5/8



IL 710  
11/16 x 1 11/16



IL 732  
9/16 x 1 3/4

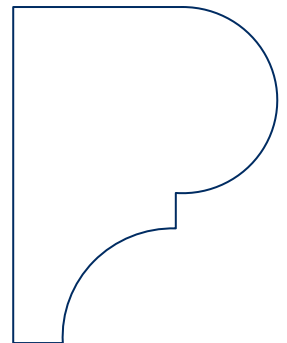

IL 748  
1 3/8 x 1 3/4

Profiles Shown 1:1

Greenwich, CT  
203.531.8050 914.939.2500

Bethel, CT  
203.748.5629

Newtown, CT  
203.364.0074

Stamford, CT  
203.348.3761

Westport, CT  
203.226.3321

Shrub Oak, NY  
914.245.5050



1" - 2"

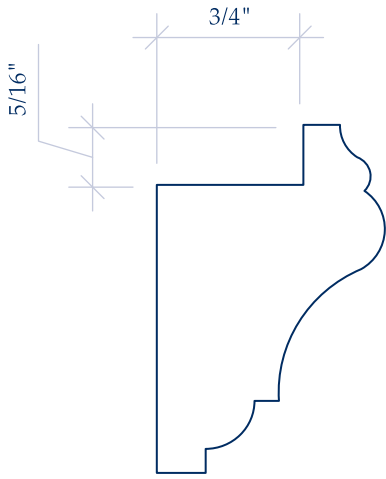

**IL 749**  
1 3/16 x 1 13/16

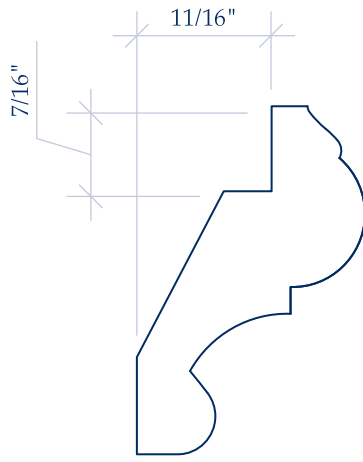

**IL 725**  
1 3/16 x 1 13/16

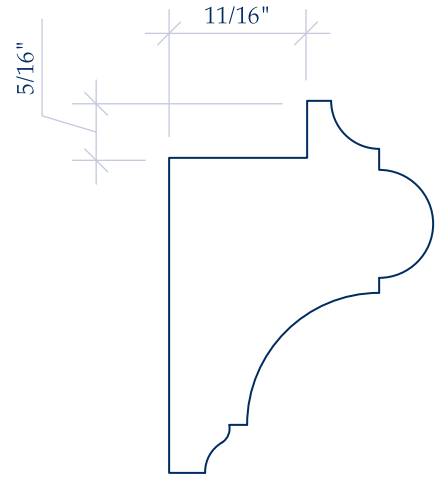

**IL 735**  
1 3/8 x 1 15/16

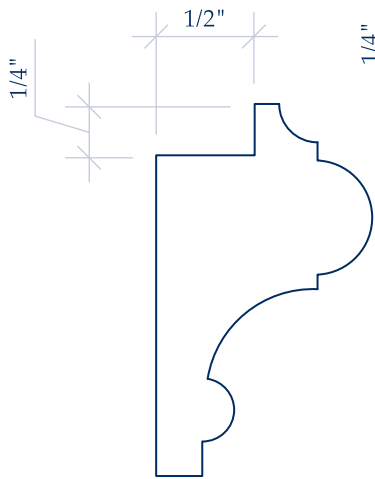

**IL 734**  
1 1/8 x 1 15/16

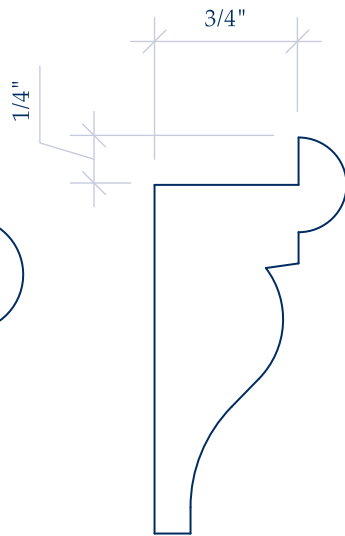

**IL 750**  
1 x 2 1/16

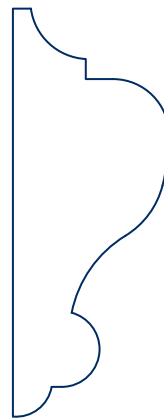

**IL 721**  
13/16 x 2 1/8

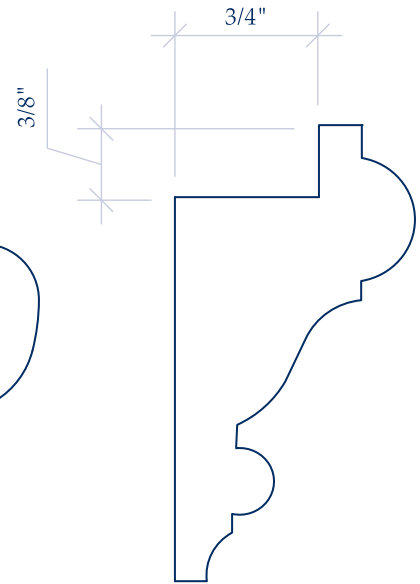

**IL 751**  
1 1/4 x 2 3/8

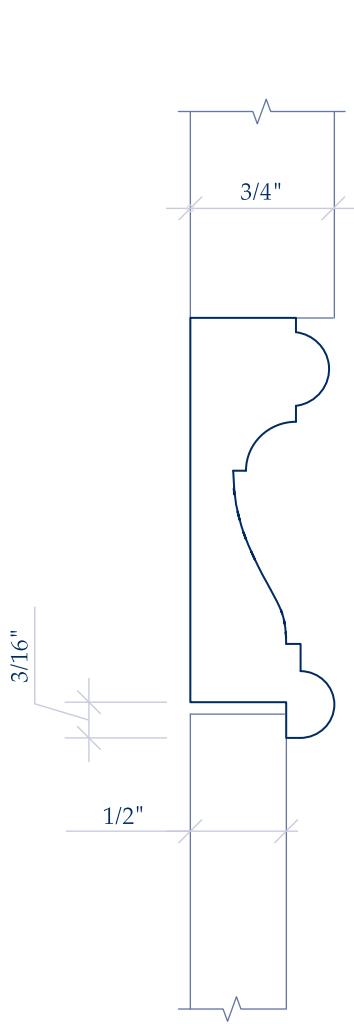

**IL 752**  
3/4 x 2 3/16

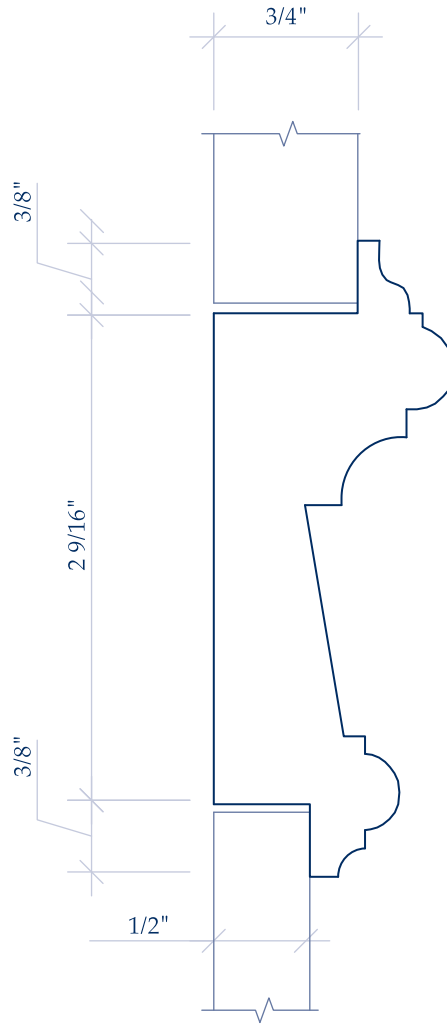

**IL 753**  
1 1/4 x 3 5/16

The Profiles on this page simulate raised panels, each accepting a 1/2" board on one side and a 3/4" board on the other. (see section and elevation on following page)

Profiles Shown 1:1

Greenwich, CT  
203.531.8050 914.939.2500

Bethel, CT  
203.748.5629

Newtown, CT  
203.364.0074

Stamford, CT  
203.348.3761

Westport, CT  
203.226.3321

Shrub Oak, NY  
914.245.5050



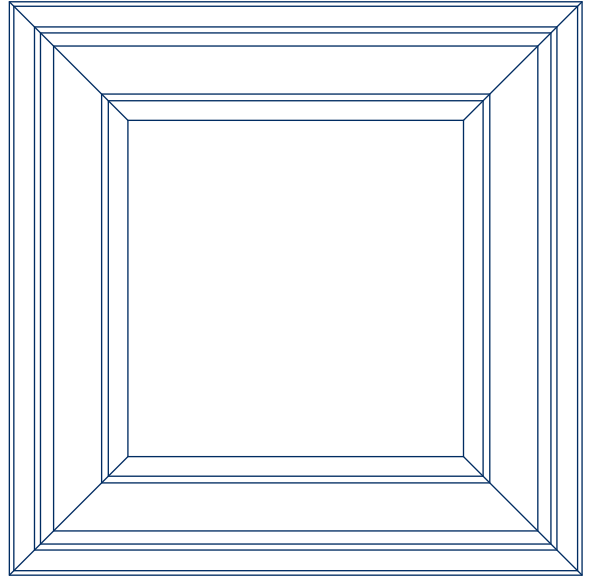
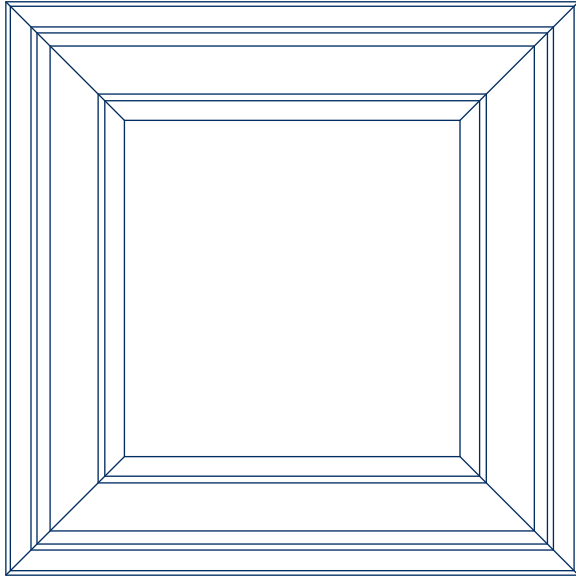

IL 752  
3/4 x 2 3/16

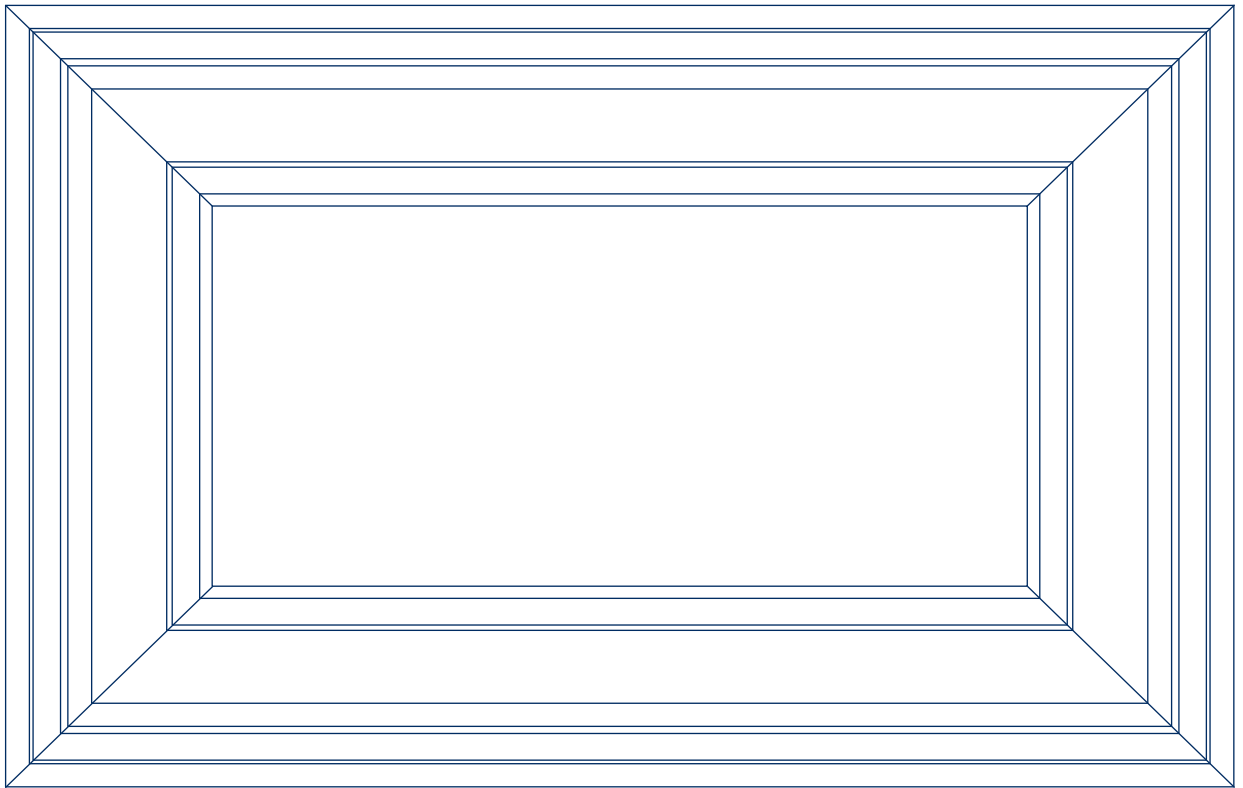

IL 753  
1 1/4 x 3 5/16

To create a classic raised panel look you may choose the traditional method or try one of our new mouldings, which simulate the look with less work. *(see previous page)*





2" - 3"



IL 404  
11/16 x 2 3/4

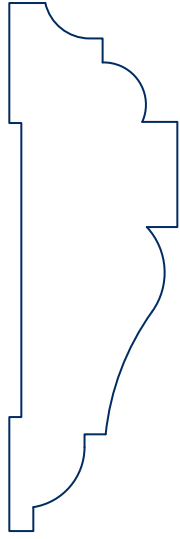

IL 422  
7/8 x 2 3/4



IL 415  
7/8 x 2 3/4

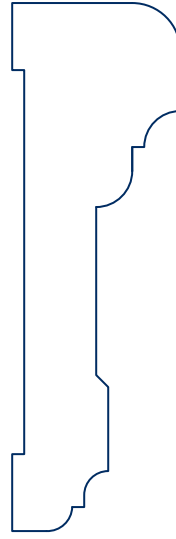

IL 402  
7/8 x 2 3/4

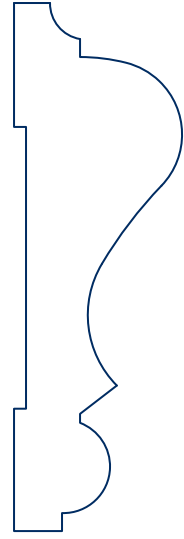

IL 405  
7/8 x 2 3/4



IL 419  
7/8 x 3

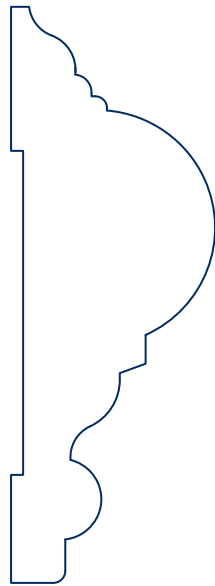

IL 421  
1 1/16 x 3

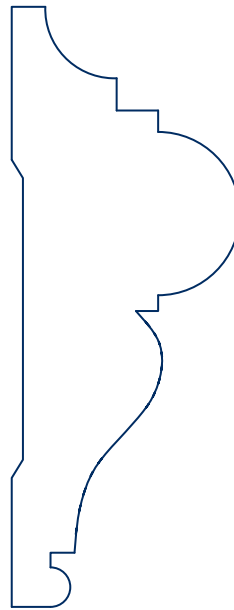

IL 427  
1 3/16 x 3 1/8

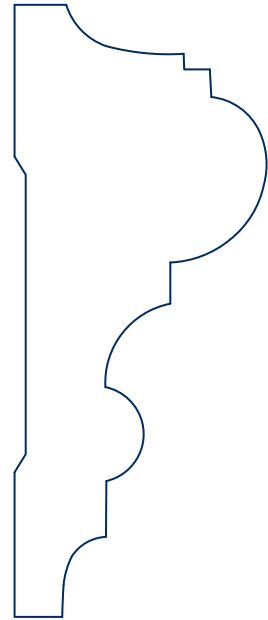

IL 428  
1 5/16 x 3 3/16

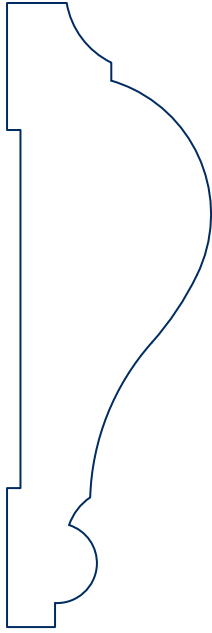

IL 411  
1 1/16 x 3 1/4

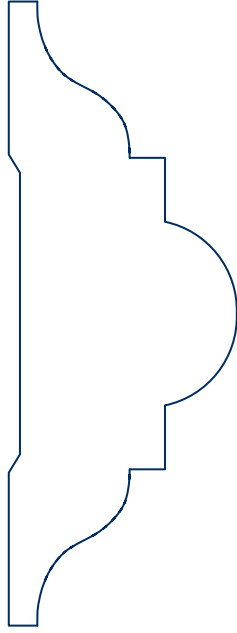

IL 429  
1 3/16 x 3 1/4

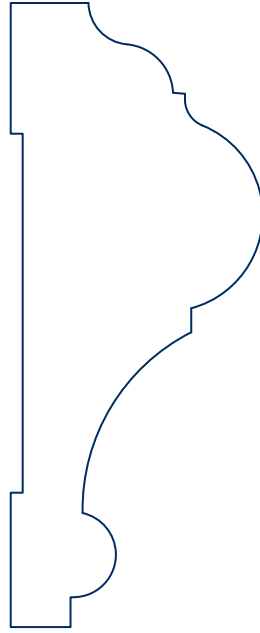

IL 417  
1 5/16 x 3 1/4

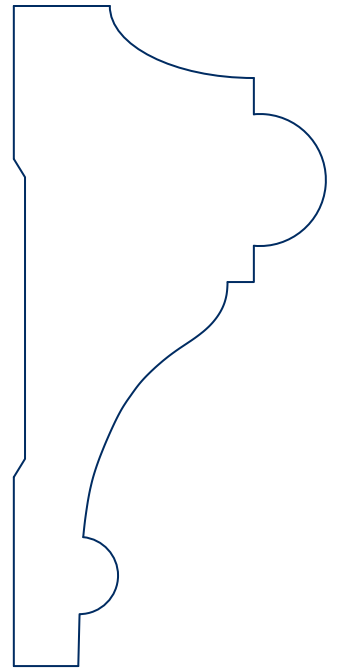

IL 430  
1 5/8 x 3 7/16

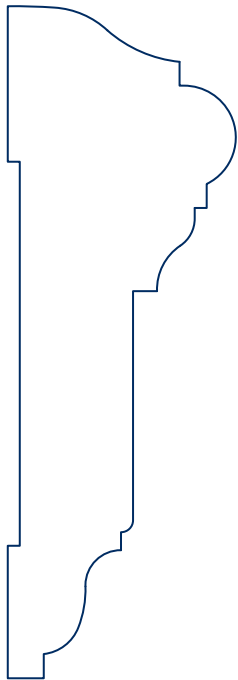

IL 418  
1 3/16 x 3 1/2

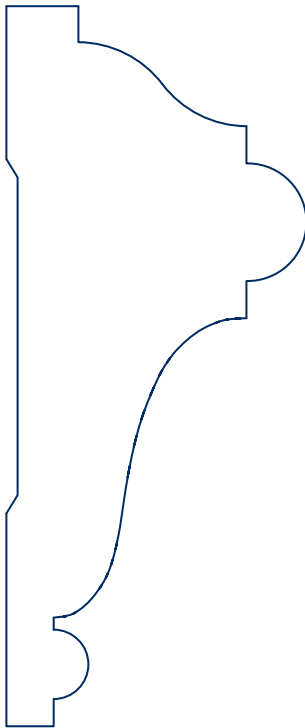

IL 432  
1 9/16 x 3 3/4

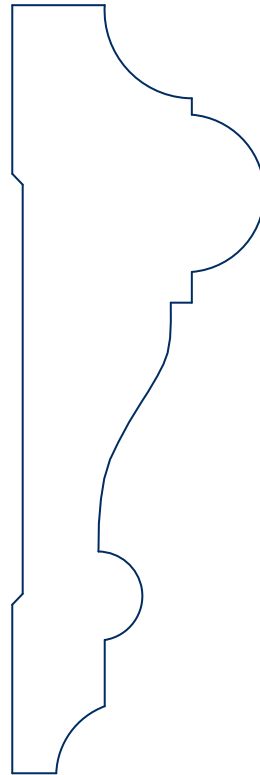

IL 433  
1 5/16 x 4

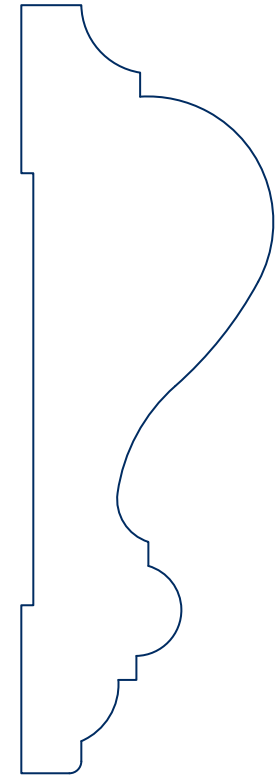

IL 410  
1 5/16 x 4

Profiles Shown 1:1

Greenwich, CT  
203.531.8050 914.939.2500

Bethel, CT  
203.748.5629

Newtown, CT  
203.364.0074

Stamford, CT  
203.348.3761

Westport, CT  
203.226.3321

Shrub Oak, NY  
914.245.5050





IL CRB3  
1/2 x 7/8



IL CRB2  
5/8 x 7/8

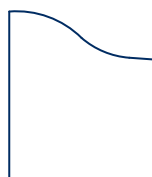

IL CRB1  
3/4 x 7/8

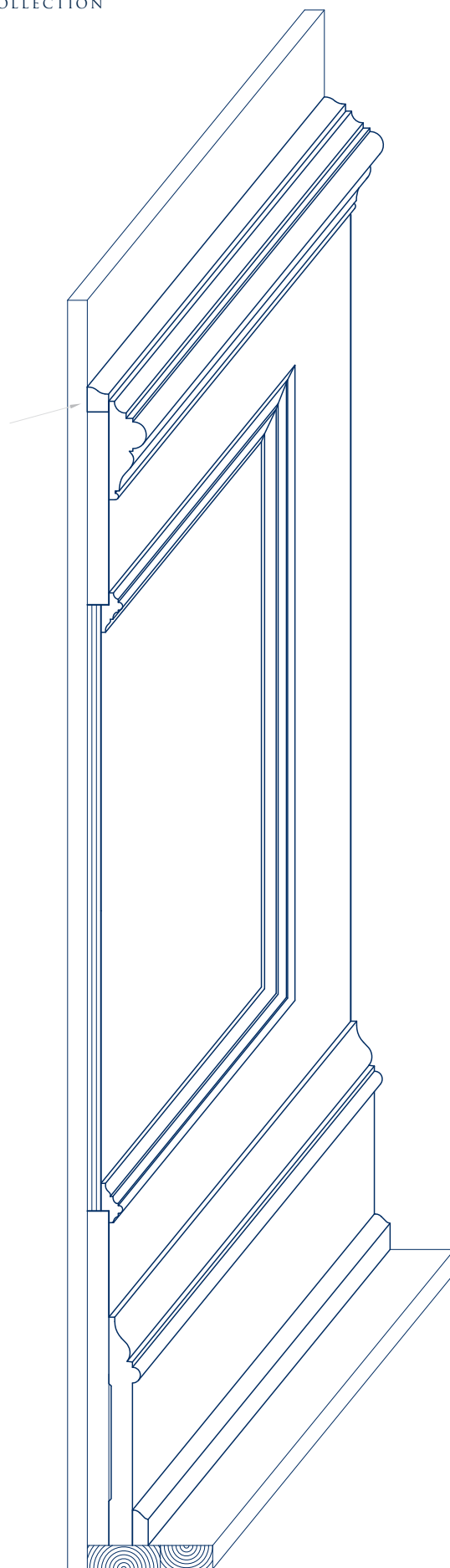

Chair Rail Build-Outs can be used as a transition when a chair rail is applied to a panel and a gap or space remains.

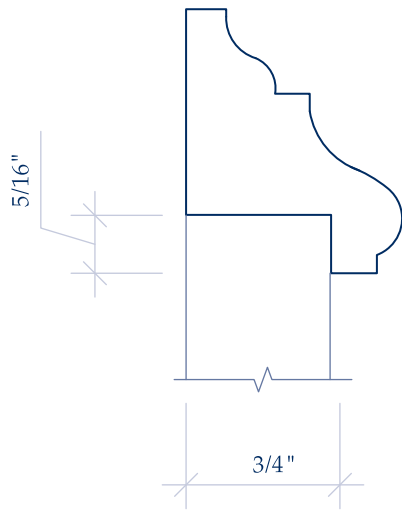

**IL 425**  
1 1/8 x 1 3/8

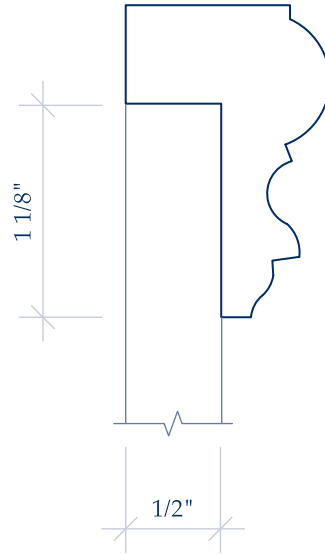

**IL 426**  
1 1/16 x 1 5/8

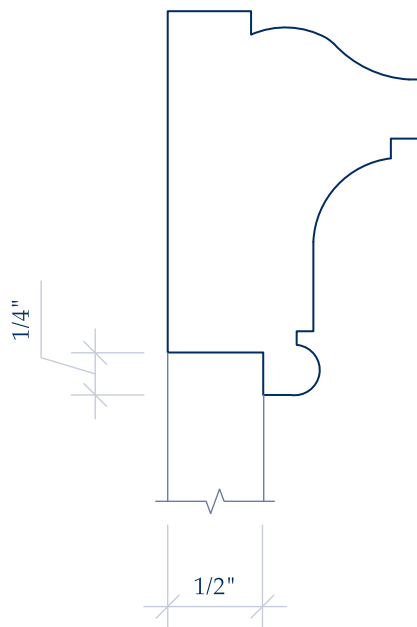

**IL 424**  
1 5/16 x 2

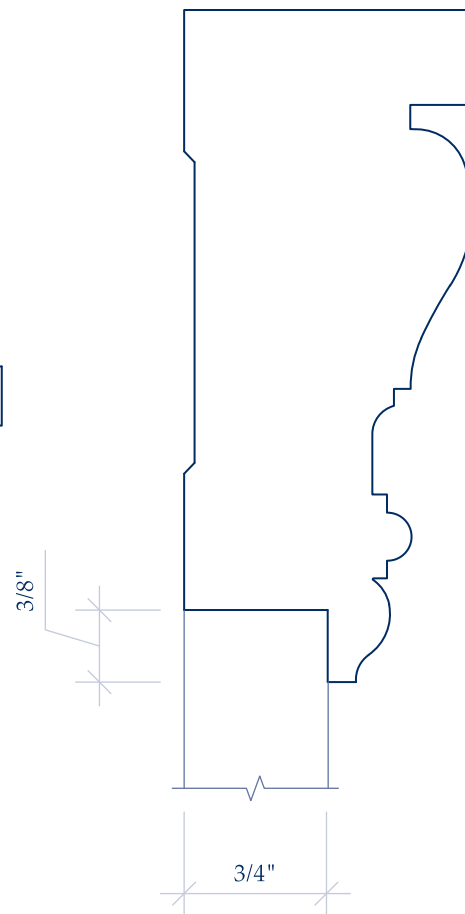

**IL 431**  
1 1/2 x 3 1/2

Profiles Shown 1:1





**IL 811**  
7/8 x 1 3/4

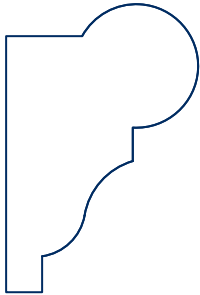

**IL 813**  
1 x 1 1/2

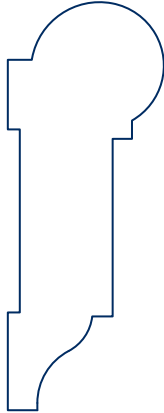

**IL 810**  
13/16 x 2 1/8

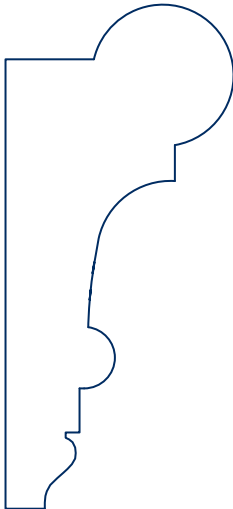

**IL 814**  
1 3/16 x 2 5/8

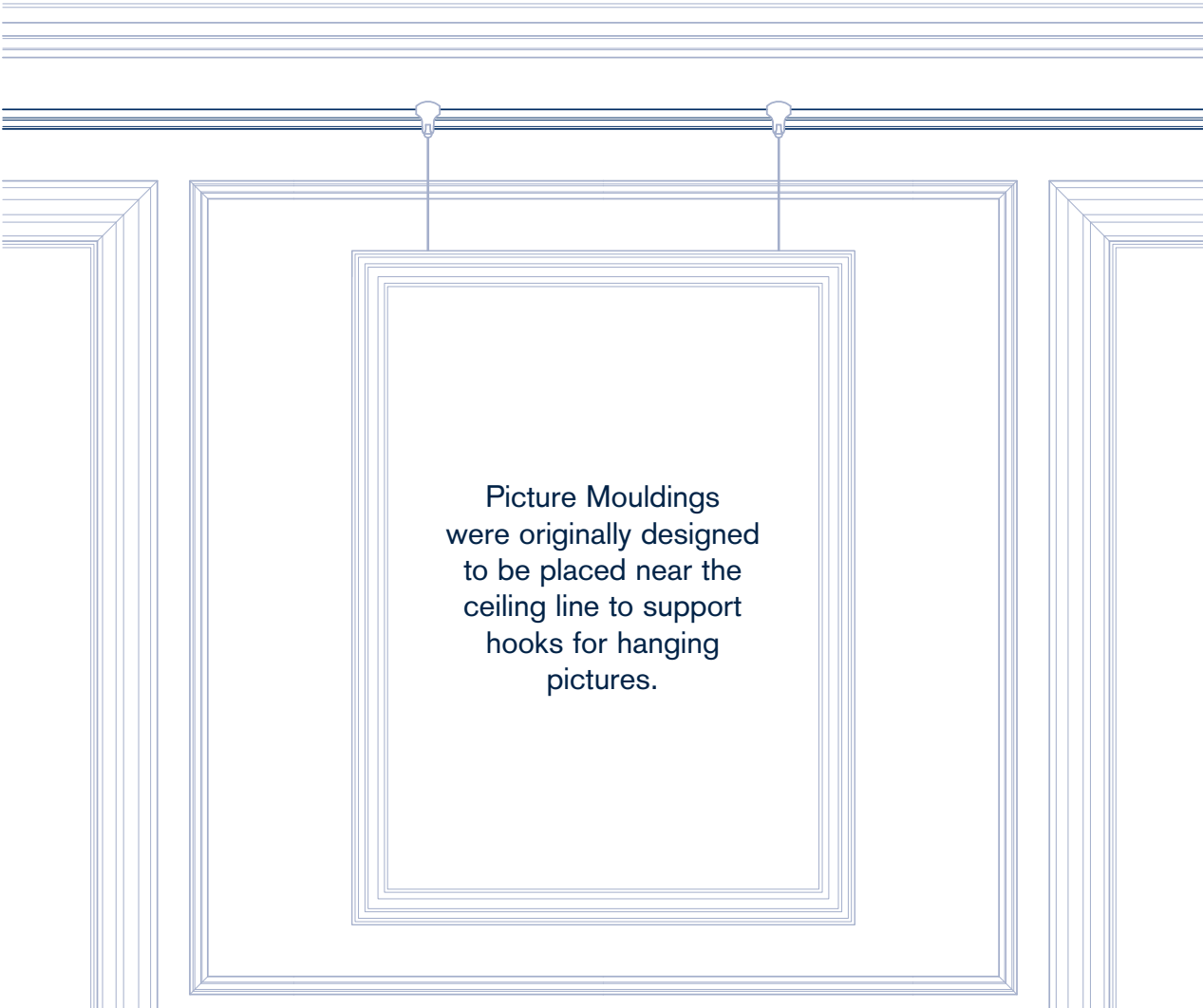

Picture Mouldings  
were originally designed  
to be placed near the  
ceiling line to support  
hooks for hanging  
pictures.







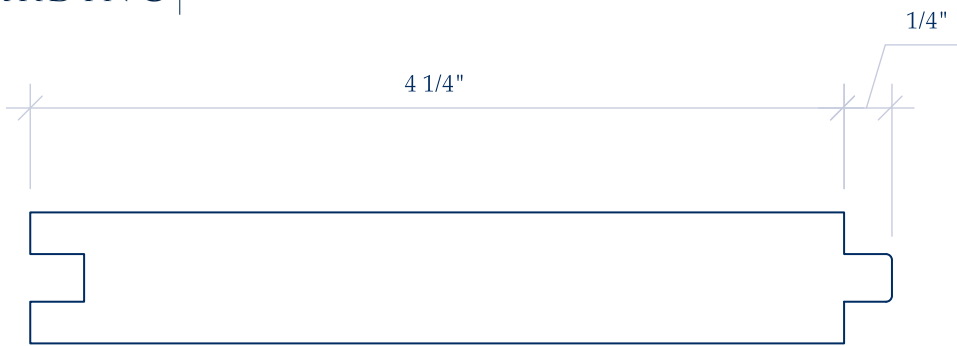

**IL 910**  
 Shown as 11/16 x 4 1/2  
 (Available in all thicknesses and widths)  
 Available through Special Order

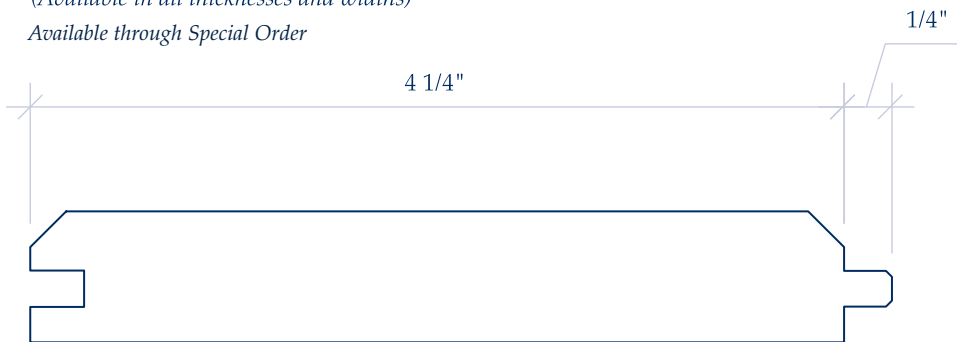

**IL 915**  
 Shown as 11/16 x 4 1/2  
 (Available in all thicknesses and widths)  
 Available through Special Order

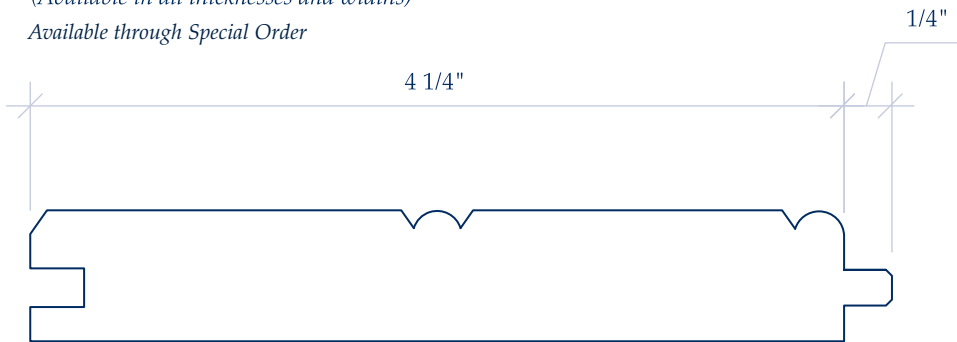

**IL 916**  
 Shown as 11/16 x 4 1/2  
 (Available in all thicknesses and widths)  
 Available through Special Order

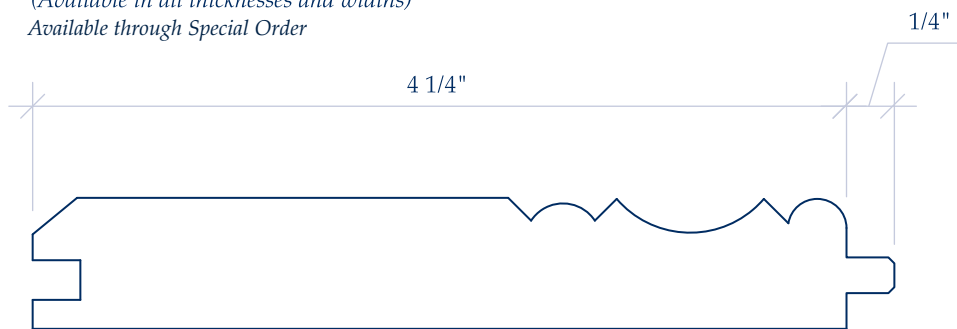

**IL 917**  
 Shown as 11/16 x 4 1/2  
 (Available in all thickness and widths)  
 Available through Special Order







IL 510  
5/8 xVaries

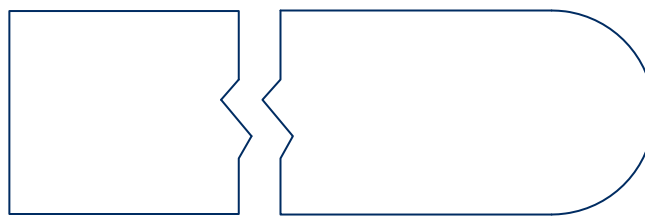

IL 514  
1 1/16 xVaries

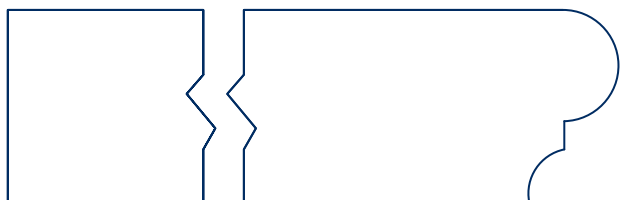

IL 503  
1 xVaries

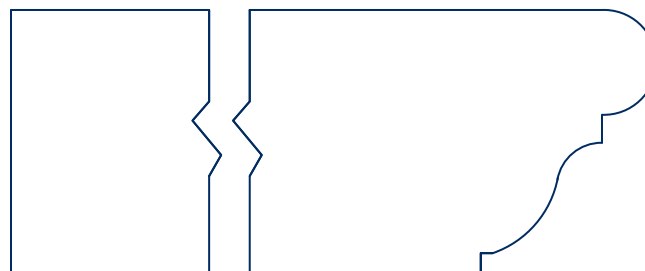

IL 511  
1 3/8 xVaries

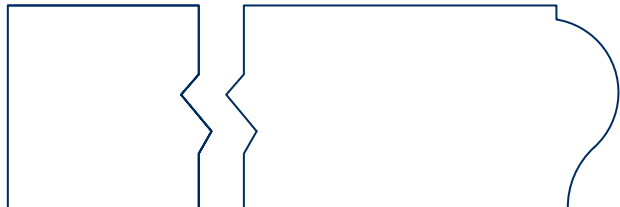

IL 504  
1 1/16 xVaries

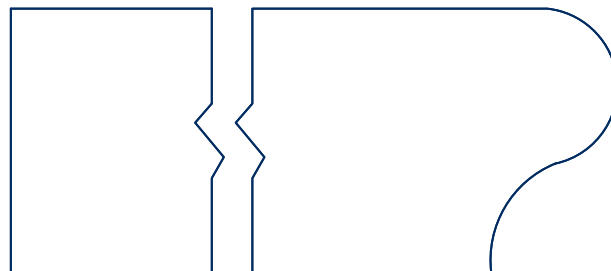

IL 512  
1 3/8 xVaries

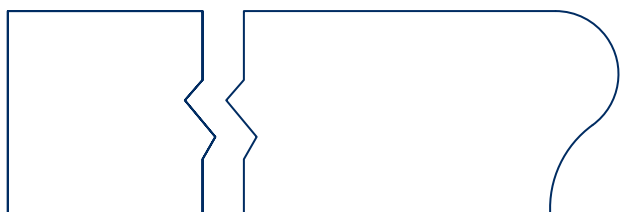

IL 505  
1 1/16 xVaries

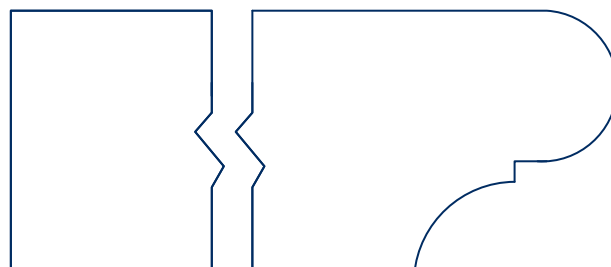

IL 513  
1 3/8 xVaries





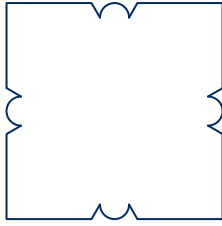

**IL 050 118**  
1 1/8 x 1 1/8  
*Available through  
Special Order*

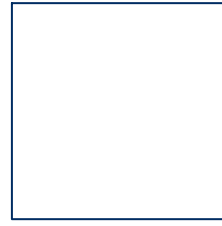

**IL 051 118**  
1 1/8 x 1 1/8  
*Available through  
Special Order*

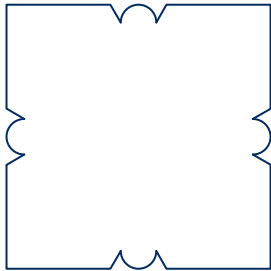

**IL 050 138**  
1 3/8 x 1 3/8  
*Available through  
Special Order*

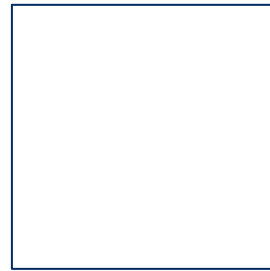

**IL 051 138**  
1 3/8 x 1 3/8  
*Available through  
Special Order*

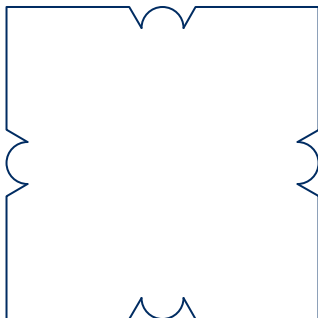

**IL 050 158**  
1 5/8 x 1 5/8  
*Available through  
Special Order*



**IL 051 158**  
1 5/8 x 1 5/8  
*Available through  
Special Order*

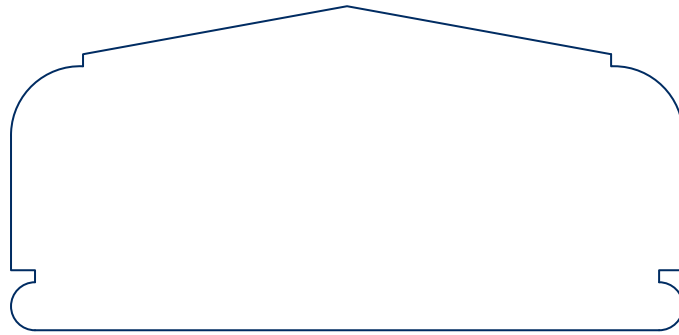

**IL 040** Available through  
 1 11/16 x 3 1/2 Special Order

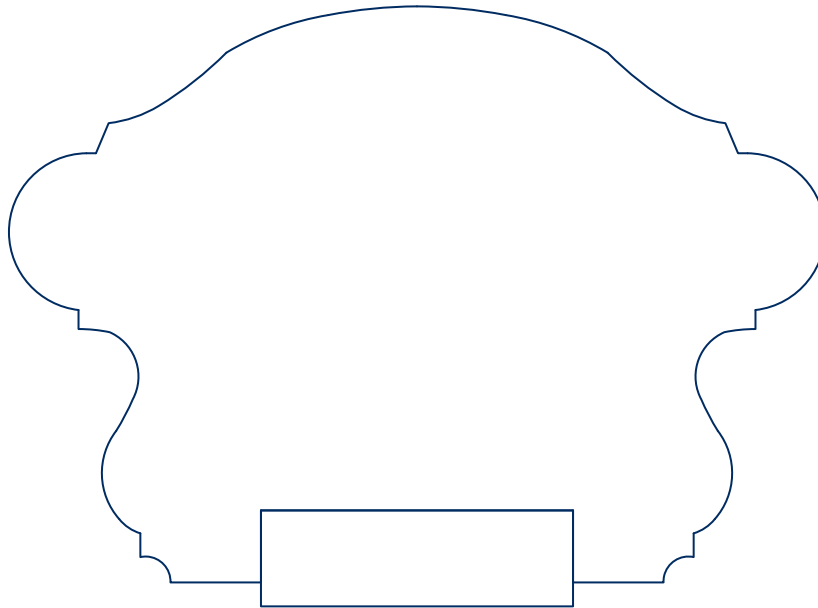

**IL 060** Available through  
 3 x 4 1/4 Special Order

**IL 070** Available through  
 1/2 x 1 5/8 Special Order

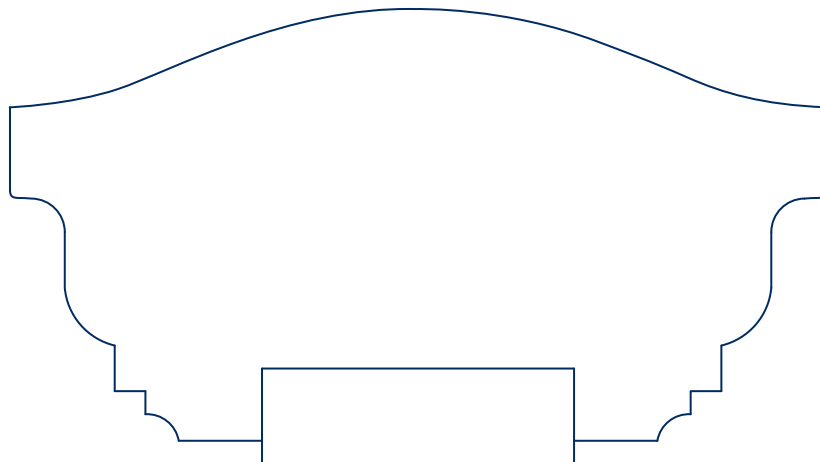

**IL 061**  
 2 1/4 x 4 1/4

**IL 070**  
 1/2 x 1 5/8

Available through Special Order Available through Special Order

Profiles Shown 1:1



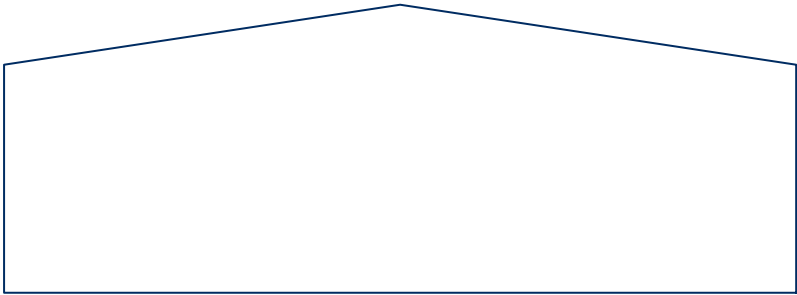

**IL 030**  
1 1/2 x 4 1/8  
*Available through  
Special Order*

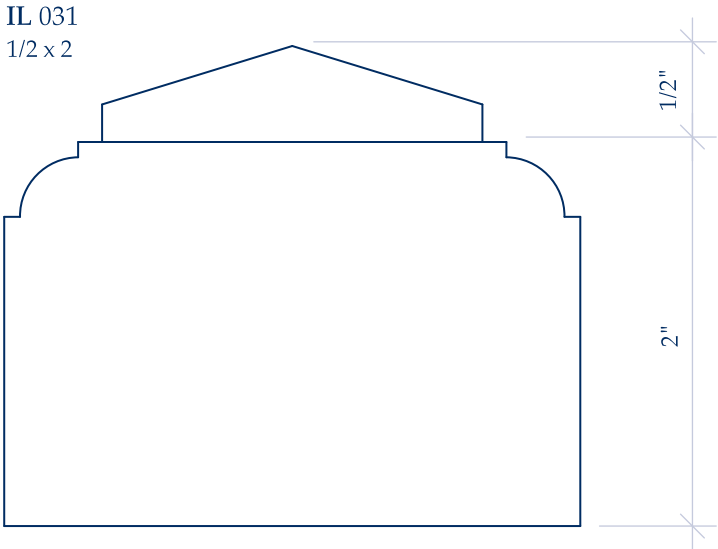

**IL 031**  
1/2 x 2

**IL 032**  
2 x 3  
*Available through  
Special Order*



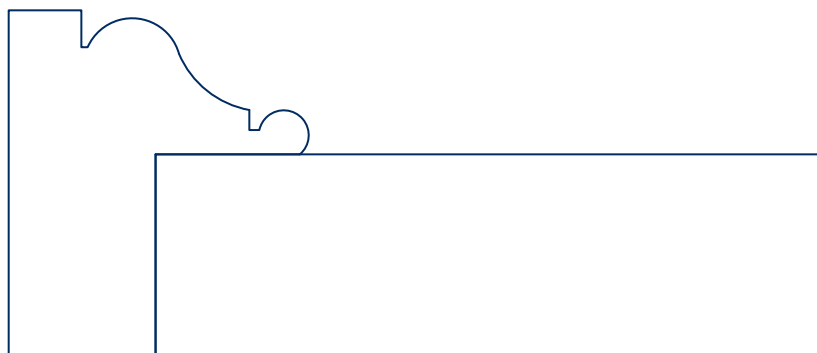

**IL E02BB**  
 1 9/16 x 1 13/16  
*(same profile as IL02BBE  
 from previous catalog)*  
*Available through  
 Special Order*

**IL E0544**  
 1 1/16 x 3 1/2  
*(same profile as IL544E  
 from previous catalog)*

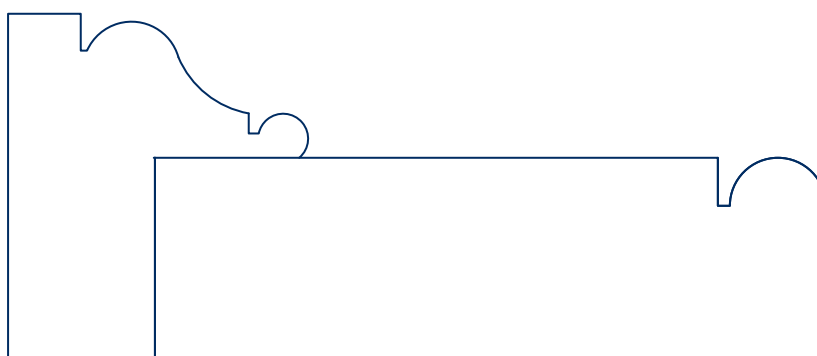

**IL E02BB**  
 1 9/16 x 1 13/16  
*(same profile as IL02BBE  
 from previous catalog)*  
*Available through  
 Special Order*

**IL E0544B**  
 1 1/16 x 3 1/2  
*(same profile as IL544BE  
 from previous catalog)*

Profiles Shown 1:1

**Greenwich, CT**  
 203.531.8050 914.939.2500

**Bethel, CT**  
 203.748.5629

**Newtown, CT**  
 203.364.0074

**Stamford, CT**  
 203.348.3761

**Westport, CT**  
 203.226.3321

**Shrub Oak, NY**  
 914.245.5050



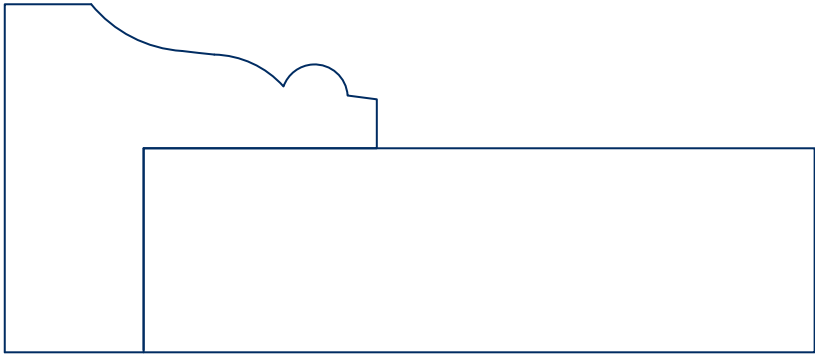

**IL E01BB**  
1 13/16 x 1 15/16  
*(same profile as IL01BBE  
from previous catalog)*

**IL E0544**  
1 1/16 x 3 1/2  
*(same profile as IL544E  
from previous catalog)*

*Available through  
Special Order*

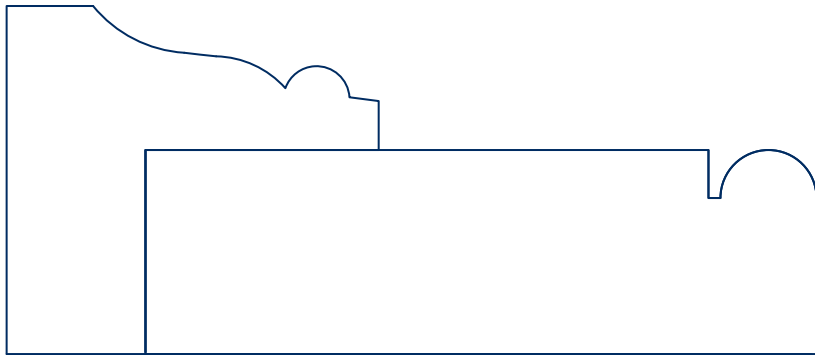

**IL E01BB**  
1 13/16 x 1 15/16  
*(same profile as IL01BBE  
from previous catalog)*

**IL E0544B**  
1 1/16 x 3 1/2  
*(same profile as IL544BE  
from previous catalog)*

*Available through  
Special Order*





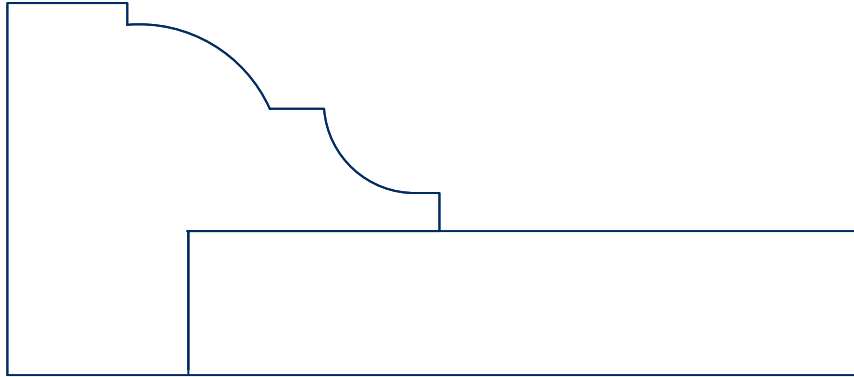

**IL E03BB**  
 1 15/16 x 2 1/4  
*(same profile as IL03BBE  
 from previous catalog)*

**IL E0444**  
 3/4 x 3 1/2  
*(same profile as IL444E  
 from previous catalog)*

*Available through  
 Special Order*

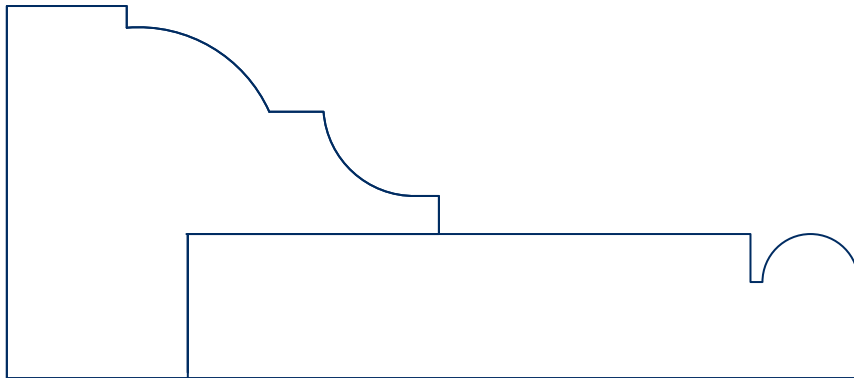

**IL E03BB**  
 1 15/16 x 2 1/4  
*(same profile as IL03BBE  
 from previous catalog)*

**IL E0444B**  
 3/4 x 3 1/2  
*(same profile as IL444BE  
 from previous catalog)*

*Available through  
 Special Order*

Profiles Shown 1:1

**Greenwich, CT**  
 203.531.8050 914.939.2500

**Bethel, CT**  
 203.748.5629

**Newtown, CT**  
 203.364.0074

**Stamford, CT**  
 203.348.3761

**Westport, CT**  
 203.226.3321

**Shrub Oak, NY**  
 914.245.5050



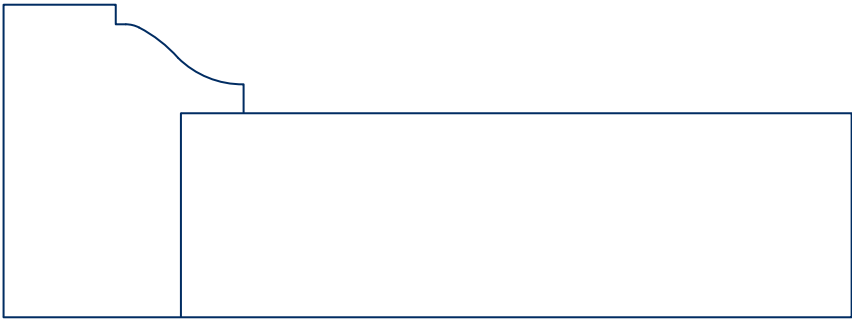

**IL E013BB**  
1 5/8 x 1 1/4  
*Available through  
Special Order*

**IL E0544**  
1 1/16 x 3 1/2  
*(same profile as IL544E  
from previous catalog)*

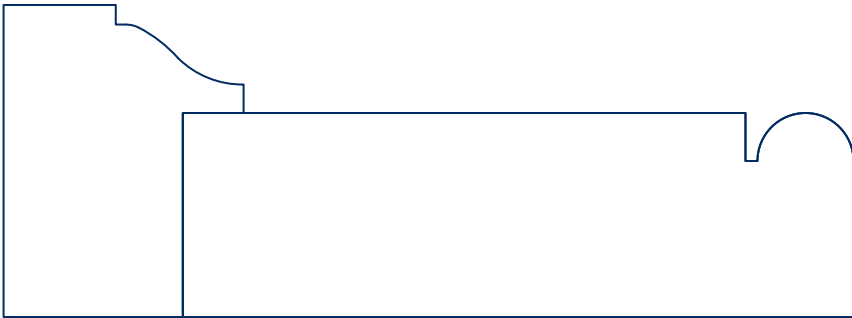

**IL E013BB**  
1 5/8 x 1 1/4  
*Available through  
Special Order*

**IL E0544B**  
1 1/16 x 3 1/2  
*(same profile as IL544BE  
from previous catalog)*





**IL E010**  
1/2 x 3/4  
*Available through  
Special Order*



**IL E011**  
11/16 x 1  
*Available through  
Special Order*



**IL E012**  
3/4 x 1 9/16  
*Available through  
Special Order*

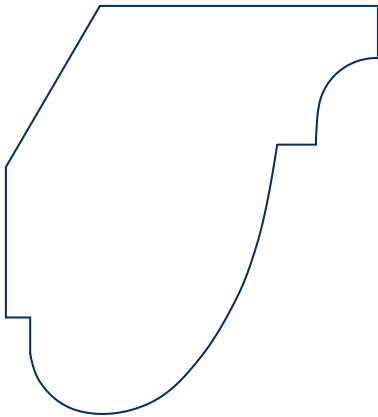

**IL E09**  
2 1/8 x 1 15/16  
*Available through  
Special Order*

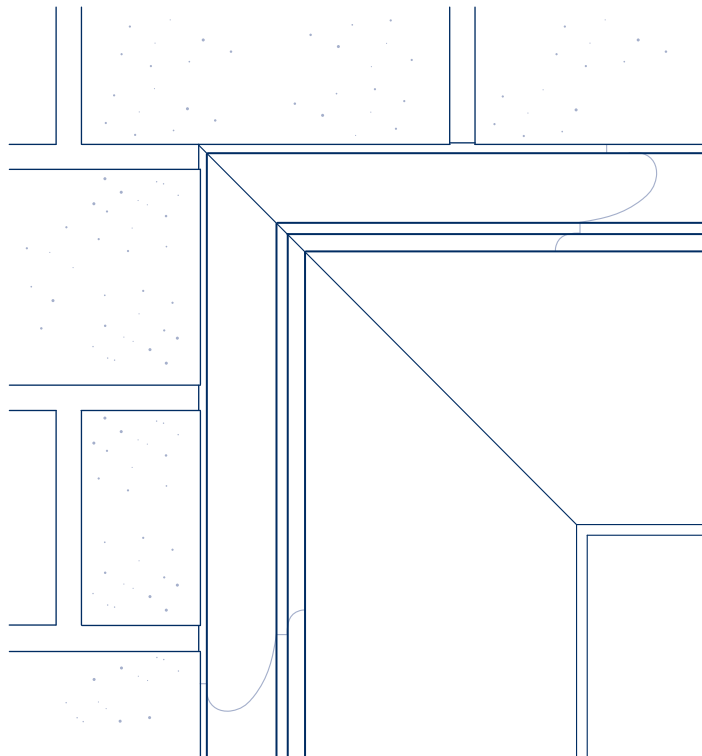

Profiles Shown 1:1

**Greenwich, CT**  
203.531.8050 914.939.2500

**Bethel, CT**  
203.748.5629

**Newtown, CT**  
203.364.0074

**Stamford, CT**  
203.348.3761

**Westport, CT**  
203.226.3321

**Shrub Oak, NY**  
914.245.5050



2" - 5"

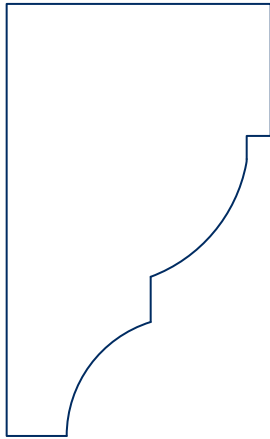

**IL E08** Available through  
1 3/8 x 2 1/4 Special Order

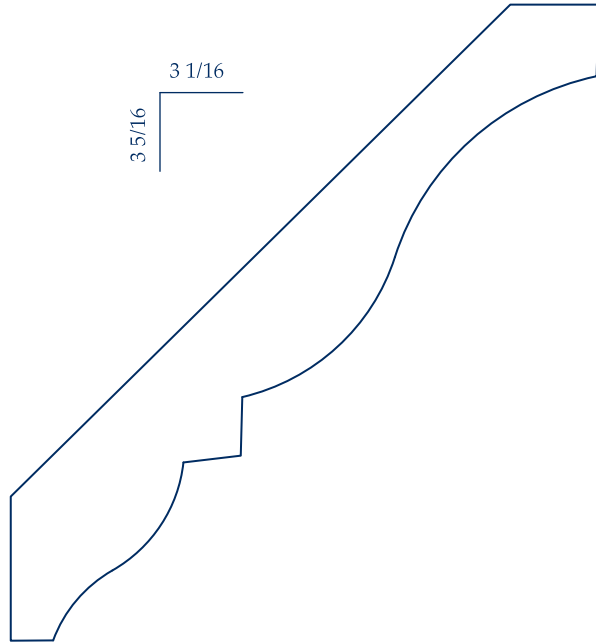

**IL E05** Available through  
1 1/16 x 4 1/2 Special Order

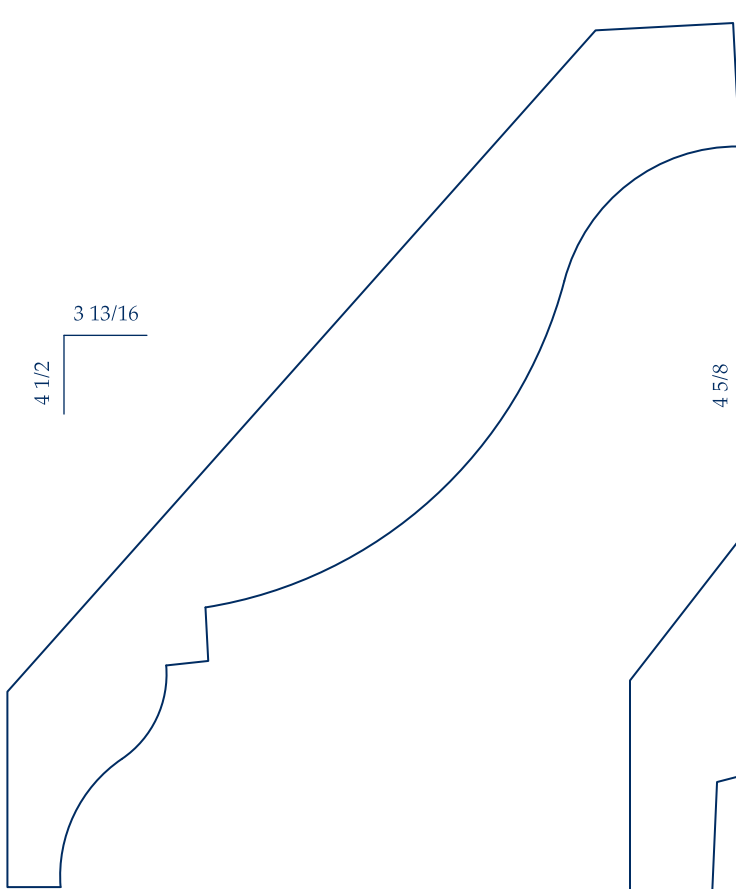

**IL E04** Available through  
1 x 5 7/8 Special Order

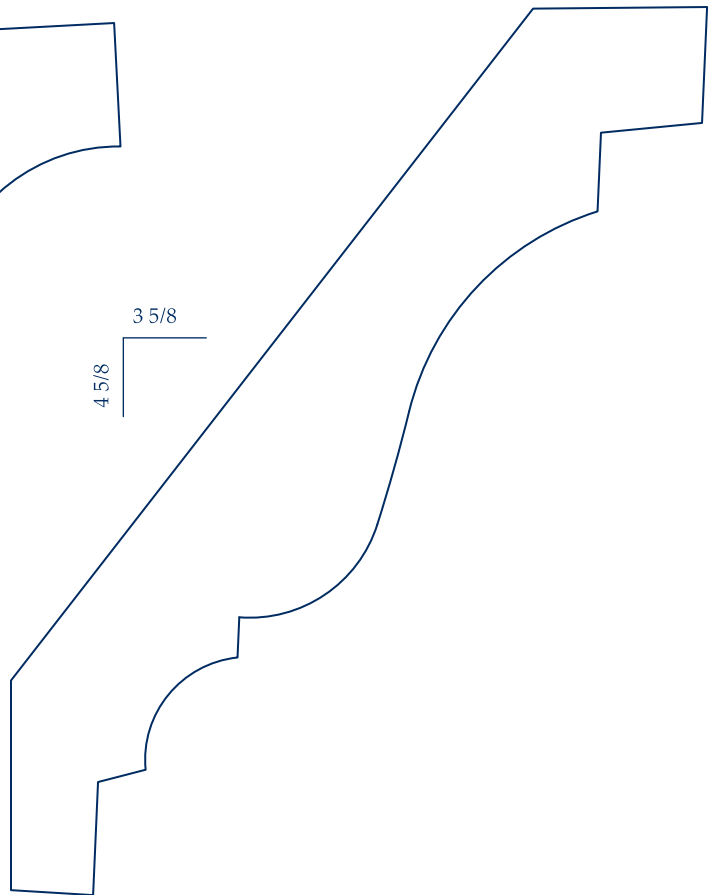

**IL E02** Available through  
1 1/16 x 5 7/8 Special Order



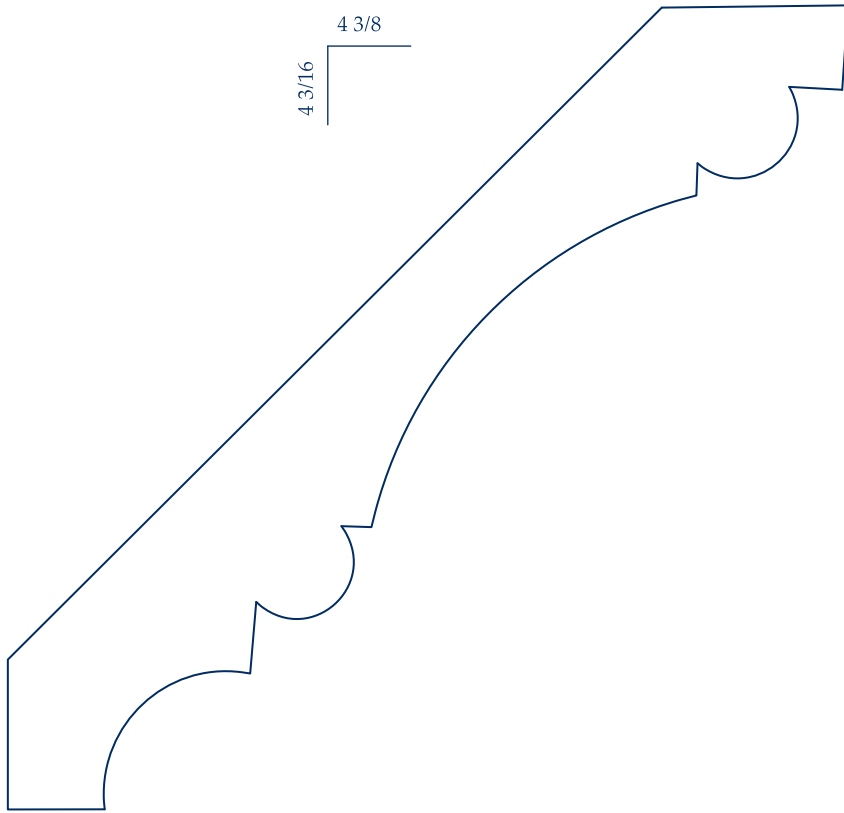

**IL E01**  
1 x 6 1/16  
*Available through  
Special Order*

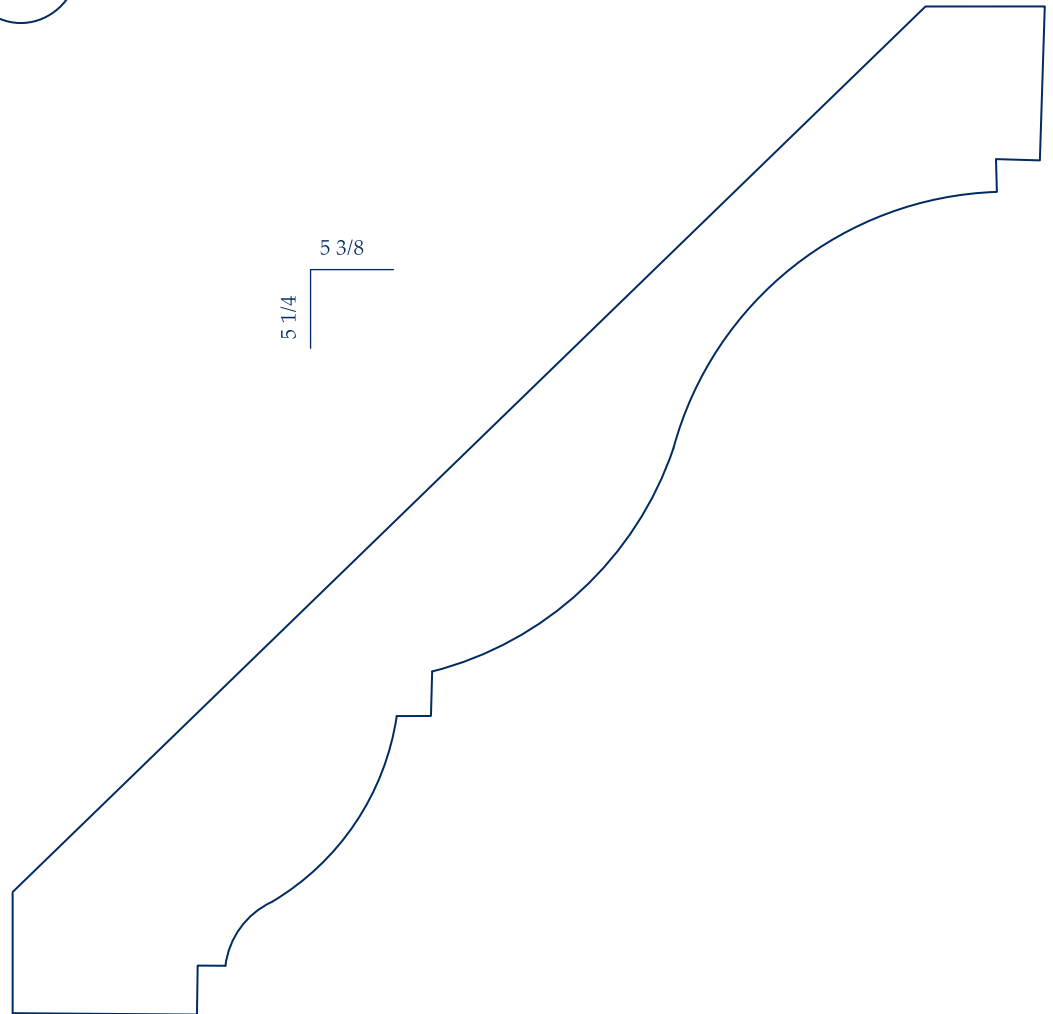

**IL E03**      *Available through  
Special Order*  
1 1/8 x 7 1/2

Profiles Shown 1:1

**Greenwich, CT**  
203.531.8050 914.939.2500

**Bethel, CT**  
203.748.5629

**Newtown, CT**  
203.364.0074

**Stamford, CT**  
203.348.3761

**Westport, CT**  
203.226.3321

**Shrub Oak, NY**  
914.245.5050



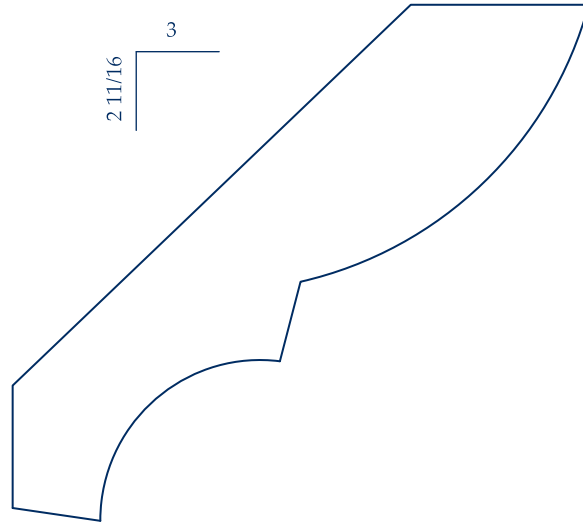

**IL E06**  
15/16 x 4  
*Available through  
Special Order*

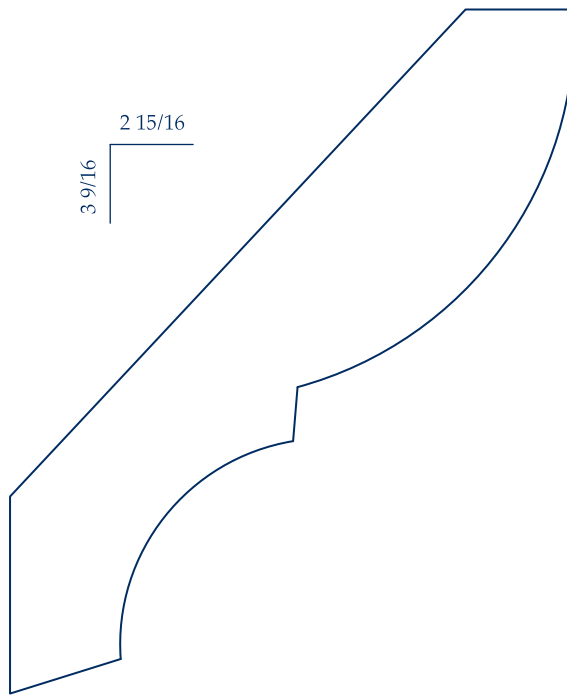

**IL E07** *Available through  
Special Order*  
1 x 4 5/8

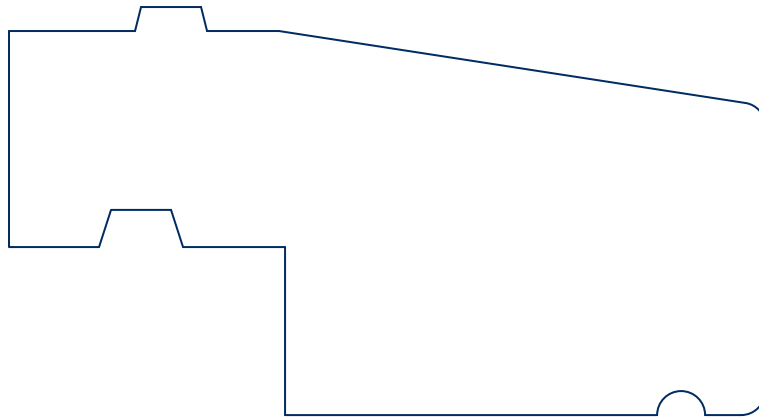

**IL MSSM** (*made specifically for Marvin™ Double Hung Windows*)  
2 1/8 x 3 15/16  
*Available through Special Order*

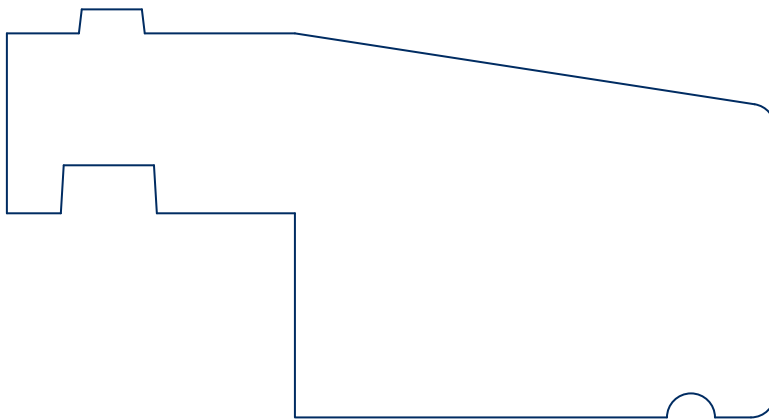

**IL MCS** (*made specifically for Marvin™ Casement Windows*)  
2 1/8 x 4  
*Available through Special Order*

Profiles Shown 1:1

**Greenwich, CT**  
203.531.8050 914.939.2500

**Bethel, CT**  
203.748.5629

**Newtown, CT**  
203.364.0074

**Stamford, CT**  
203.348.3761

**Westport, CT**  
203.226.3321

**Shrub Oak, NY**  
914.245.5050







CUSTOM MILLWORK











## The IL Custom Millwork Shop

Custom Millwork has been a division of Interstate + Lakeland Lumber Corp. since the birth of the company in 1922. Over our proud 100-year history, the shop has evolved into its present configuration. With over 20,000 square feet of space dedicated to millwork production, combined with state-of-the-art machinery and technology, we are able to produce a wide range of millwork projects in a timely fashion. The millwork sales, estimating and production team all have an average of over 25 years in the millwork field. This experience, combined with our modern facility, allows us to work with architects, designers, custom and speculative builders, to create quality millwork that will truly enhance any type of design project.

## Turning Drawings into Dream Homes

Once a plan is submitted, our experienced estimators review the plan and compile a list of materials needed to create a particular project. If further clarification is required, our in-house CAD department will create a shop drawing to indicate how the project



will be built. This allows everyone to have a clear image and understanding of what materials are being supplied and how they will be used. Once the drawings have been approved, if necessary, three-dimensional mock-ups can be provided to see exactly how the finished profiles will look in the designated space. After delivery of the materials to the job site, a sales representative will stop by to assist with any field questions that might arise to ensure a quality finished product.

### **Interstate Design Center: Your New Showroom**

In 2008, we opened our award-winning window, door and millwork showroom. It is interesting to note that this showroom occupies the space that housed the company's first millwork shop from 1922. This newly renovated space was created to provide an environment where one can come with their ideas and plans and begin the exciting process of having their drawings turned into a beautiful home with exceptional architectural trim and millwork. We encourage you to stop in or call to make an appointment with our knowledgeable millwork sales staff.



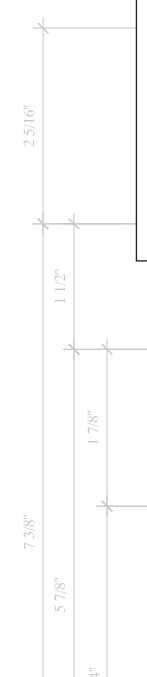
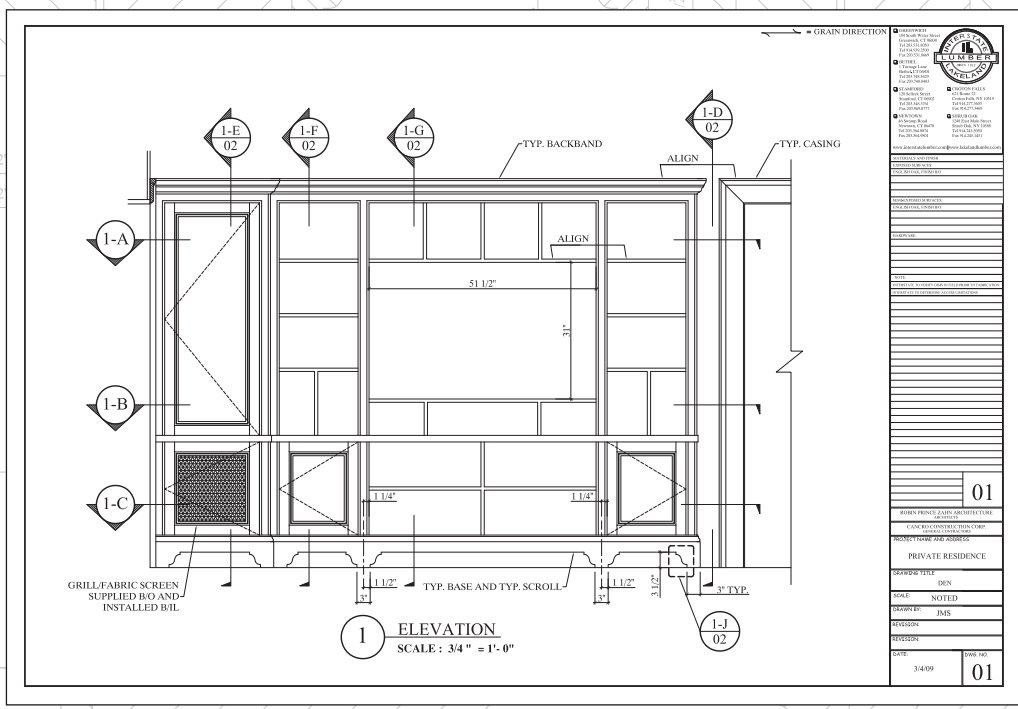
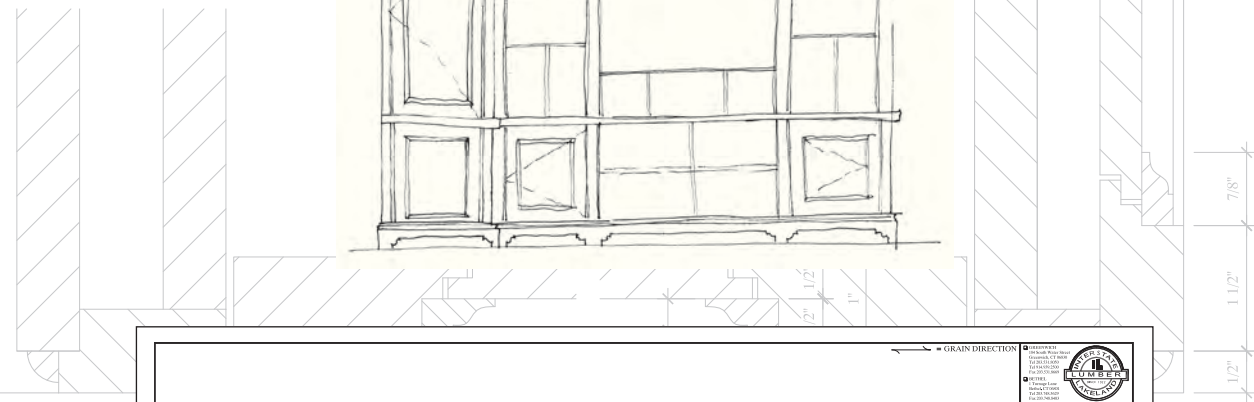
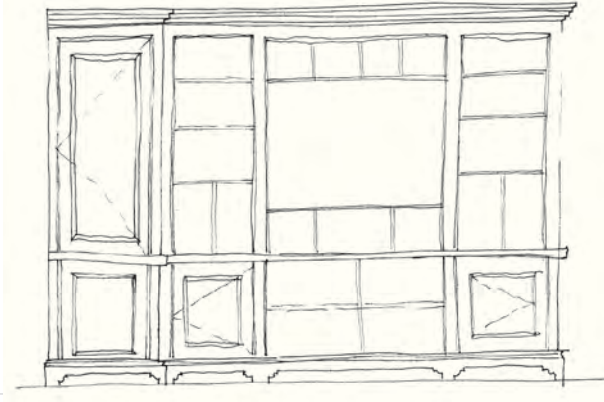



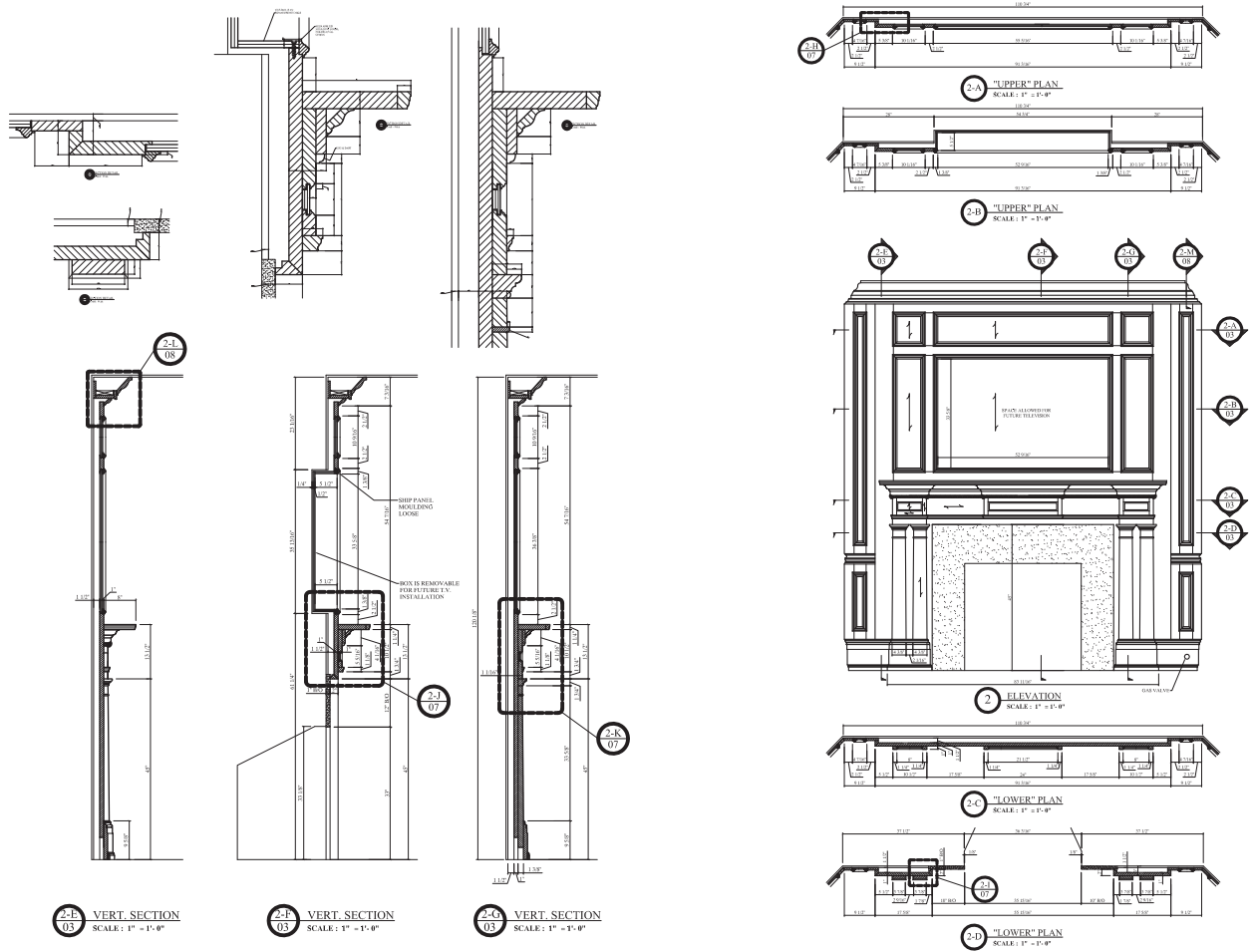

## CAD & Shop Drawing

In 2007, we welcomed a CAD artist to our staff. Some projects need a working set of drawings due to their complexity, and at times, a shop drawing can ensure that a simple project remains simple, like in the case of a custom casing with accompanying plinth, or a custom knife drawing for a raking crown. Once we have received plans, have provided our estimate and are awarded the job, the shop drawing process may begin. Although we are not in the drafting service business, we understand the necessity of shop drawings and their pivotal role in the final fabrication of the project, be it a custom library or custom exterior architectural detail. Shop drawings are assurance that your project will be delivered with all the correct specifications and design details as they were originally created.

**AutoCAD is used  
to produce our  
architectural  
drawings.**



King post built to match the existing architectural detail on an extension to the original building.



Ornate bracket built to replace the original architectural detail.



Newel post and rail was rotting and stained.



Rebuilt to match existing and maintain the unique look of the home.

## RESTORATION

The IL Custom Millwork Shop specializes in restoring historical architectural elements and details. We have been called on to create mouldings to match existing profiles for additions, restore original cornices, match ornate Victorian brackets, carve detailed historic blocks, replace custom railings and newel posts and much more. Accurate, quality Restoration work helps to maintain the unique character of your dream home.





Cedar brackets add detail to this re-creation home.



Custom trim work complements this arch top window dormer.



Blocks and columns create a stately portico.



Screened porch with interchangeable panels.





Ornate brackets line a Victorian-style building.



Mahogany Pergola shades a patio.

## EXTERIORS

The IL Custom Millwork Shop can create a range of exterior architectural details to add charm and character to your dream home projects. Our projects have included pediment heads, brackets, columns and pilasters, cornices, posts and rails, pergolas, complete screened porches with interchangeable storm/screen panels, rafter tails, shutters and much more. We also create exterior millwork in Cellular PVC (Please see the Custom PVC Millwork section on the following page).

### INCLUDING

- Brackets**
- Cornice Parts**
- Columns & Pilasters**
- Posts & Rails**
- Pergolas**
- Pediment Heads**
- Rafter Tails**
- Screened Porches**
- and more**





Cellular PVC arches sit above custom columns in this charming entrance.



Custom Cellular PVC trellis work was a perfect complement to a pool area where moisture is commonplace.





Cellular PVC cupola topped with copper.



Cellular PVC is an ideal material for radius work, as seen on this balcony.

## CUSTOM PVC MILLWORK

Quickly taking the building world by storm, Cellular PVC materials are a smart choice for exterior projects such as cupolas, newels, rails, balusters, columns, exterior trim and more. The IL Custom Millwork Shop has produced many incredible projects that may have otherwise been impossible in natural wood. We are so excited about our advancements with Cellular PVC that we have opened a showroom/workroom dedicated to our custom PVC millwork.



Curved cornice, window and casing on curved stairwell.



Custom curved exterior trim produced in AZEK®.



Curved casing wraps this arch top window.



Archway in the River Room at Interstate Design Center.





Curved panel jamb and custom door in cherry wood library.



Curved cornice and paneled jamb lead to curved stairwell.

## RADIUS & CURVED WORK

We are able to handle any type of arch or radius work, from basic to complex. The highly desirable curved work is a daily request at the IL Custom Millwork Shop. With only 6" of a moulding sample, we can create a match and give it a curve to your specifications. For interior trim and panelwork, exterior casings, jambs, railings and more, the IL Custom Millwork Shop stands ready to add the finishing touch to your dream home project.

### INCLUDING

- Arches**
- Curved Casings**
- Curved Panels**
- Paneled Jambs**
- Curved Crowns**
- Curved Baseboards**
- Curved Doors**
- Convex or Concave**
- and more**



Repeated arched openings enhance this traditional space.



Den wrapped in reclaimed antique heart pine.



Elegant foyer with curved panels, casings and crowns.







Custom boarding warms the dining area's walls and ceiling.

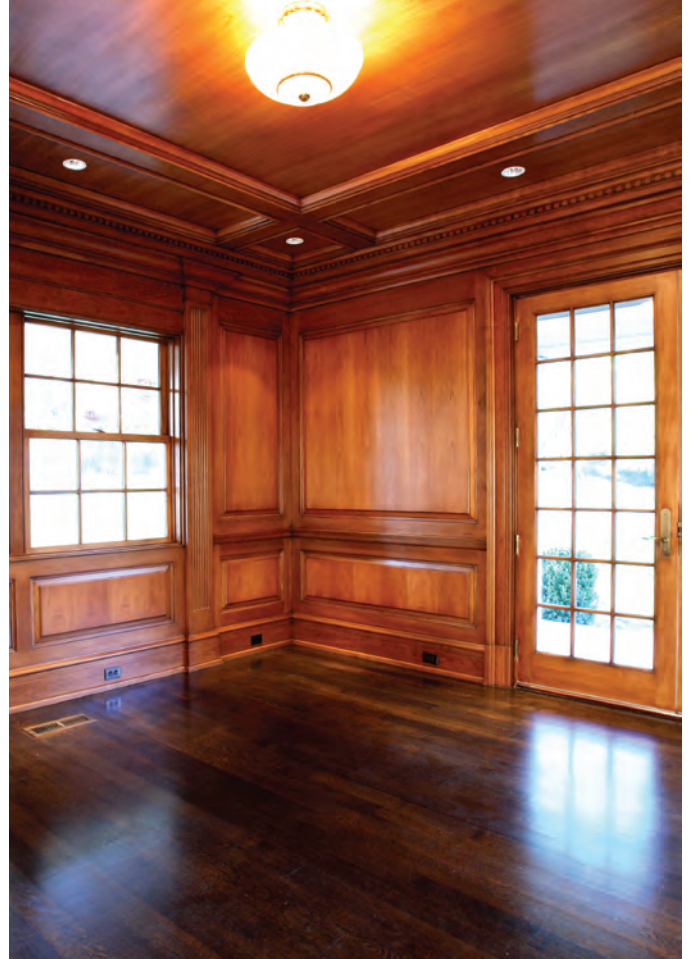

Cherry wood library embellished with panels and custom mouldings.

## INTERIOR SPACES

Custom Millwork helps to create remarkable rooms complete with warmth, and rich with interest. Explore the natural beauty of wood with book matched layered-up veneering or profiles run from reclaimed lumber. Wall surfaces can be enhanced with custom panel work or boarding. Our portfolio is filled with examples of every kind of room including custom libraries, barrooms, elegant foyers and much more. Excellent design combined with expert installation of our quality craftsmanship equals gorgeous rooms in your dream home.

### INCLUDING

- Custom Libraries
- Book Matched Veneers
- Reclaimed Wood
- Panel Work
- Custom Boarding
- Radius & Curved Work
- Formal Rooms
- and more





Unique cornice and pilaster with appliqué case this opening.



Custom library details in the River Room at Interstate Design Center.



Fluted pilaster in cherry wood.



Ornate custom mantle with carvings, appliques and mouldings.



Custom cornice with blocks and crown moulding.



Key block on custom curved cased window with compound crown above.

## ARCHITECTURAL ELEMENTS

The IL Custom Millwork Shop specializes in creating and recreating traditional architectural millwork. Provide a photo or sketch with rough dimensions and we can construct a unique architectural element. Over the years we have completed work on mantles, pilasters, columns, arches, panel work, coffered ceilings, dentil blocks and more. In addition to these architectural elements we carry a full line of embossed profiles and ornaments from White River™ and Ornamental Mouldings®. Houses become dream homes when embellished with fine architectural elements and details.

### INCLUDING

- Mantles**
- Pilasters**
- Columns**
- Arches**
- Coffered Ceilings**
- Key Blocks**
- Dentil Blocks**
- Appliqués**
- and more**





## FRONT ENTRYWAYS

A front entryway helps to create a transition from the outside to the inside of a home. The IL Custom Millwork Shop has created front entries that include custom porticos, paneled jambs, and doors in a variety of styles and species of wood. We have the ability to work with something as simple as a sketch or photo as well as with a sophisticated shop drawing. Let our staff help create a unique and inviting front entranceway to your dream home.



## CABINETRY

The IL Custom Millwork Shop has been asked to produce cabinetry and built-ins throughout the years. We recently added staff with the refined skills needed for this specialized task and are proud to consider Cabinetry and Built-ins a new division of our Custom Millwork Shop. When your projects call for Cabinetry and Built-ins, you can rely on the IL Custom Millwork Shop.



IL#	BOARD DIMENSION	TYPE	PAGE(S)	IL#	BOARD DIMENSION	TYPE	PAGE(S)
IL 030	1 1/2 x 4 1/8	Ext. Bottom Rail	106	IL 137S	1/2 x 1 1/8	Shoe Moulding	43
IL 031	1/2 x 2	Ext. Bottom Rail	106	IL 138S	1/2 x 1 3/4	Shoe Moulding	43
IL 032	2 x 3	Ext. Bottom Rail	106	IL 2000	1 5/16 x 4 3/4	Casing	18
IL 040	1 11/16 x 3 1/2	Ext. Hand Rail	105	IL 2001	1 1/8 x 5	Casing	19
IL 050 118	1 1/8 x 1 1/8	Ext. Baluster	104	IL 2002	1 5/16 x 5	Casing	19
IL 050 138	1 3/8 x 1 3/8	Ext. Baluster	104	IL 2003	1 5/16 x 5	Casing	19
IL 050 158	1 5/8 x 1 5/8	Ext. Baluster	104	IL 2004	1 11/16 x 5	Casing	19
IL 051 118	1 1/8 x 1 1/8	Ext. Baluster	104	IL 2005	1 3/4 x 5	Casing	20
IL 051 138	1 3/8 x 1 3/8	Ext. Baluster	104	IL 2006	11/16 x 3 3/16	Casing	22, 32
IL 051 158	1 5/8 x 1 5/8	Ext. Baluster	104	IL 2006B	1 5/16 x 1 3/16	Back Band	22, 26, 32
IL 060	3 x 4 1/4	Ext. Hand Rail	105	IL 2007	7/8 x 4	Casing	24, 32
IL 061	2 1/4 x 4 1/4	Ext. Hand Rail	105	IL 2007B	1 11/16 x 1 5/8	Back Band	24, 27, 32
IL 070	1/2 x 1 5/8	Ext. Top Rail	105	IL 2008	7/8 x 3	Casing	23
IL 101	11/16 x 5 1/4	Baseboard	35	IL 2008B	1 3/4 x 2 1/4	Back Band	23, 27
IL 101S	3/8 x 13/16	Shoe Moulding	43	IL 2009	7/8 x 3 5/16	Casing	24
IL 102S	1/2 x 3/4	Shoe Moulding	43	IL 2009B	1 3/4 x 2 3/16	Back Band	24, 27
IL 103C	11/16 x 1 5/8	Base Cap	41	IL 201	13/16 x 3 1/2	Casing	12
IL 103S	1/2 x 1 1/4	Shoe Moulding	43	IL 2010	7/8 x 3 7/8	Casing	24
IL 104	11/16 x 5 1/4	Baseboard	35	IL 2010B	1 3/4 x 1 13/16	Back Band	24, 27
IL 104S	1/2 x 1 1/16	Shoe Moulding	43	IL 202	1 1/16 x 3 1/2	Casing	13
IL 1047	11/16 x 7	Baseboard	36	IL 203	1 1/16 x 4 1/4	Casing	17
IL 105	11/16 x 5 1/4	Baseboard	38	IL 204	1 x 3 1/2	Casing	12
IL 105C	3/4 x 1 5/8	Base Cap	38, 41	IL 205	1 1/16 x 4	Casing	16
IL 105S	1/2 x 1 1/8	Shoe Moulding	43	IL 206	1 1/4 x 4 1/8	Casing	23
IL 106	7/8 x 4 5/8	Baseboard	38	IL 206B	1 1/2 x 7/8	Back Band	23, 26
IL 106C	13/16 x 2 7/8	Base Cap	38, 42	IL 207	11/16 x 3	Casing	12
IL 107	11/16 x 5 1/4	Baseboard	34	IL 207PB	13/16 x 3 1/4	Plinth Block	30
IL 1077	11/16 x 7	Baseboard	36	IL 212	1 5/16 x 4 1/2	Casing	18
IL 110C	3/4 x 1 1/8	Base Cap	41	IL 213	11/16 x 3 3/4	Casing	14
IL 111	1 1/16 x 7 5/8	Baseboard	37	IL 214	7/8 x 3 1/2	Casing	12
IL 112	1 1/16 x 6 1/8	Baseboard	35	IL 217	13/16 x 3 7/8	Casing	15
IL 113	15/16 x 7 1/16	Baseboard	39	IL 218	1 x 4 1/2	Casing	18
IL 113C	1 1/16 x 2	Base Cap	39, 42	IL 219	1 3/8 x 4 1/2	Casing	18, 32
IL 1138	15/16 x 8	Baseboard	39	IL 219PB	1 1/2 x 4 3/4	Plinth Block	30
IL 117	11/16 x 7	Baseboard	36	IL 220	1 3/16 x 4 7/8	Casing	19
IL 117C	3/4 x 1 11/16	Base Cap	41	IL 221	1 1/4 x 5 1/2	Casing	20
IL 118	11/16 x 5 3/4	Baseboard	35	IL 222	1 5/16 x 6 1/2	Casing	21
IL 118C	3/4 x 1 3/4	Base Cap	41	IL 223	1 1/16 x 4	Casing	16
IL 119	11/16 x 5 1/4	Baseboard	34	IL 224	1 1/16 x 4 1/4	Casing	17
IL 1197	11/16 x 7	Baseboard	36	IL 224PB	1 3/16 x 4 1/2	Plinth Block	30
IL 120	11/16 x 5 1/4	Baseboard	34	IL 225	1 1/16 x 3 5/8	Casing	14
IL 120C	11/16 x 1 1/4	Base Cap	41	IL 226	11/16 x 2 7/8	Casing	22
IL 121	11/16 x 5 1/4	Baseboard	34	IL 226B	1 7/16 x 1 5/8	Back Band	22, 26
IL 122	3/4 x 4 3/8	Baseboard	34	IL 227	3/4 x 3 1/2	Casing	12
IL 123	3/4 x 2 5/8	Baseboard	34	IL 228	1 1/16 x 5	Casing	20
IL 123C	11/16 x 1	Base Cap	41	IL 229	3/4 x 4 1/2	Casing	25
IL 124	1 x 7 1/4	Baseboard	37	IL 229B	1 5/8 x 2	Back Band	25, 27
IL 125	15/16 x 7 7/8	Baseboard	37	IL 230	9/16 x 3 1/8	Casing	22
IL 125C	1 1/4 x 2 1/2	Base Cap	42	IL 230B	1 3/8 x 1 9/16	Back Band	22, 26
IL 126	7/8 x 7 1/4	Baseboard	37	IL 232	1 1/16 x 3 3/4	Casing	15
IL 127	11/16 x 5 1/2	Baseboard	35	IL 233	13/16 x 3	Casing	22
IL 127C	3/4 x 1 13/16	Base Cap	41	IL 233B	1 7/16 x 1 1/16	Back Band	22, 26
IL 1277	11/16 x 7 1/4	Baseboard	36	IL 234	1 5/16 x 3 1/2	Casing	13
IL 128C	3/4 x 1 7/8	Base Cap	42	IL 236	1 1/16 x 3 1/4	Casing	12
IL 129C	3/4 x 1 3/4	Base Cap	41	IL 238	1 1/16 x 3 5/8	Casing	14
IL 130C	3/4 x 2	Base Cap	42	IL 239	13/16 x 3 5/8	Casing	14
IL 131C	3/4 x 2	Base Cap	42	IL 240	1 1/16 x 4	Casing	15
IL 132C	3/4 x 1 9/16	Base Cap	40, 41	IL 241	7/8 x 3 1/2	Casing	12
IL 133	1 x 7 1/4	Baseboard	37	IL 242	11/16 x 3	Casing	12
IL 134	7/8 x 5 1/2	Baseboard	40	IL 244	1 1/16 x 3 1/2	Casing	13
IL 135	7/8 x 7 1/4	Baseboard	40	IL 246	7/8 x 3	Casing	12
IL 136S	1/2 x 1 1/16	Shoe Moulding	43	IL 250	1 1/4 x 4 3/8	Casing	17



IL#	BOARD DIMENSION	TYPE	PAGE(S)	IL#	BOARD DIMENSION	TYPE	PAGE(S)
IL 251	1 3/8 x 5 3/4	Casing	21	IL 327	1 1/4 x 6 7/8	Crown	57, 80
IL 252	2 7/16 x 7 1/4	Casing	21	IL 328	1 x 3 1/2	Crown	46
IL 253B	1 3/8 x 7/8	Back Band	26	IL 329	11/16 x 2 3/4	Crown	46, 66
IL 254	1 1/16 x 2 7/16	Casing	12	IL 331	1 x 7 5/8	Crown	62
IL 255	11/16 x 2 1/4	Casing	12	IL 335	1 5/8 x 9 3/8	Crown	65
IL 258B	1 11/16 x 7/8	Back Band	26	IL 339	1 x 5	Crown	51
IL 259	13/16 x 4 1/4	Casing	25, 66	IL 342	11/16 x 3 1/2	Crown	47, 68
IL 259B	1 3/4 x 2 3/8	Back Band	25, 27	IL 344	1 x 5 5/8	Crown	52
IL 260	1 1/2 x 5 3/4	Casing	21	IL 345	1 1/2 x 8 1/2	Crown	64, 69
IL 261	11/16 x 3 9/16	Casings (Victorian)	28	IL 348	13/16 x 4 3/8	Crown	48
IL 261B	5/8 x 11/16	Casings (Victorian)	28	IL 350	11/16 x 3 5/16	Crown	46
IL 263	7/8 x 4 5/8	Casings (Victorian)	28	IL 352	15/16 x 5 1/8	Crown	51
IL 264B	3/4 x 3/4	Casings (Victorian)	28	IL 353	1 x 3 1/4	Crown	46
IL 265B	3/4 x 3/4	Casings (Victorian)	28	IL 354	1 1/4 x 6 3/4	Crown	57
IL 268	13/16 x 4 3/8	Casings (Victorian)	28	IL 355	1 1/4 x 7 7/8	Crown	63
IL 268B	11/16 x 13/16	Casings (Victorian)	28	IL 356	1 x 6 1/2	Crown	56, 79
IL 269B	5/8 x 3/4	Casings (Victorian)	28	IL 357	1 1/8 x 7 3/8	Crown	58, 74
IL 273B	1 3/8 x 1	Back Band	26	IL 358	1 3/4 x 7 1/2	Crown	60
IL 274B	1 7/16 x 1 1/2	Back Band	26	IL 359	1 5/16 x 8 7/8	Crown	65
IL 275B	1 7/16 x 1 3/4	Back Band	27	IL 360	1 1/8 x 7 1/2	Crown	59
IL 276	3/4 x 3 5/8	Casings (Victorian)	28	IL 361	1 x 6 1/16	Crown	56
IL 277	3/4 x 2 3/4	Casings (Victorian)	28	IL 362	7/8 x 4 3/8	Crown	47
IL 280	11/16 x 3 1/2	Casings (Victorian)	28	IL 363	13/16 x 4 1/2	Crown	49, 68
IL 282	1 1/2 x 5 5/8	Casing	20	IL 364	1 1/8 x 6	Crown	54, 68
IL 283	7/8 x 3 7/8	Casing	25	IL 365	13/16 x 4	Crown	47, 69
IL 283B	1 11/16 x 1 7/8	Back Band	25, 27	IL 366	1 5/16 x 6	Crown	55, 69
IL 284	7/8 x 4	Casing	23	IL 367	1 1/8 x 4 1/16	Crown	47, 70
IL 284B	1 13/16 x 1 9/16	Back Band	23, 26	IL 368	1 1/8 x 5 3/8	Crown	52, 70
IL 285	7/8 x 3 5/8	Casing	23	IL 369	1 5/16 x 6 1/2	Crown	57, 70
IL 285B	1 7/16 x 1 1/4	Back Band	23, 26	IL 370	1 3/4 x 8	Crown	63, 70
IL 286	7/8 x 4 3/8	Casing	25	IL 371	1 1/8 x 4 3/8	Crown	48, 71
IL 286B	1 3/4 x 1 9/16	Back Band	25, 26	IL 372	1 5/16 x 6	Crown	55, 71
IL 287	3/4 x 5 1/2	Casing	20	IL 373	1 3/4 x 7 1/2	Crown	60, 71
IL 288	3/4 x 3 1/2	Casing	12	IL 374	1 1/8 x 6	Crown	55, 72
IL 289	1 1/16 x 3 1/2	Casing	13, 32	IL 375	1 5/16 x 7 1/2	Crown	61, 72
IL 290	1 5/16 x 3 1/2	Casing	13	IL 376	1 5/16 x 4 7/16	Crown	48, 73
IL 291	1 5/16 x 3 11/16	Casing	14	IL 3771	1 5/16 x 5 1/8	Crown	56, 73
IL 292	1 x 3 3/4	Casing	15	IL 3772	1 9/16 x 1 1/4	Crown	56, 73
IL 293	1 1/8 x 3 3/4	Casing	15	IL 378	13/16 x 4 1/2	Crown	50, 74
IL 294	1 1/8 x 4	Casing	16	IL 379	1 1/8 x 6	Crown	54, 74
IL 295	1 5/16 x 4	Casing	16	IL 380	1 1/8 x 4 1/2	Crown	50, 75
IL 296	1 5/16 x 4	Casing	16	IL 381	1 1/8 x 5 11/16	Crown	52, 75
IL 297	1 1/4 x 4 1/8	Casing	17	IL 382	1 5/16 x 7	Crown	58, 75
IL 298	1 5/16 x 4 3/8	Casing	17	IL 383	13/16 x 4 1/2	Crown	50, 76
IL 299	1 5/16 x 4 3/4	Casing	18	IL 384	1 1/8 x 5 5/16	Crown	51, 76
IL 2XXPB	1 x 3 3/4	Plinth Block	30	IL 385	1 5/16 x 7 1/2	Crown	61, 76
IL 301	11/16 x 4 5/16	Crown	47	IL 386	13/16 x 4 1/2	Crown	49, 77
IL 303	1 x 5 5/8	Crown	52	IL 387	1 1/8 x 7 1/2	Crown	59, 77
IL 304	11/16 x 4 7/16	Crown	48, 72	IL 388	13/16 x 4 1/2	Crown	49, 78
IL 305	7/8 x 4 1/4	Crown	47	IL 389	13/16 x 6	Crown	53, 78
IL 306	1 1/16 x 6	Crown	54	IL 390	1 1/8 x 7 11/16	Crown	62, 78
IL 310	11/16 x 2	Crown	46	IL 391	13/16 x 4 3/4	Crown	50, 79
IL 311	11/16 x 4 1/2	Crown	49	IL 392	1 5/16 x 8	Crown	64, 79
IL 313	11/16 x 2 7/8	Crown	46	IL 393	1 1/8 x 5	Crown	51, 80
IL 321	1 1/16 x 5 7/8	Crown	53	IL 402	7/8 x 2 3/4	Chair Rail	94
IL 322	7/8 x 2 3/4	Crown	46	IL 404	11/16 x 2 3/4	Chair Rail	94
IL 323	1 x 3 1/2	Crown	46	IL 405	7/8 x 2 3/4	Chair Rail	94
IL 324	1 x 3 1/2	Crown	46	IL 410	1 5/16 x 4	Chair Rail	95
IL 325	7/8 x 4 3/8	Crown	48	IL 411	1 1/16 x 3 1/4	Chair Rail	95
IL 326	1 x 5 7/8	Crown	53, 66, 77	IL 415	7/8 x 2 3/4	Chair Rail	94





IL#	BOARD DIMENSION	TYPE	PAGE(S)	IL#	BOARD DIMENSION	TYPE	PAGE(S)
IL 417	1 5/16 x 3 1/4	Chair Rail	95	IL 734	1 1/8 x 1 15/16	Panel Moulding	90
IL 418	1 3/16 x 3 1/2	Chair Rail	95	IL 735	1 3/8 x 1 15/16	Panel Moulding	90
IL 419	7/8 x 3	Chair Rail	94	IL 736	7/16 x 1 11/16	Panel Moulding	84, 88
IL 421	1 1/16 x 3	Chair Rail	94	IL 737	7/16 x 3/4	Panel Moulding	88
IL 422	7/8 x 2 3/4	Chair Rail	94	IL 738	3/4 x 1	Panel Moulding	88
IL 424	1 5/16 x 2	Wainscot Cap	97	IL 739	7/16 x 1	Panel Moulding	88
IL 425	1 1/8 x 1 3/8	Wainscot Cap	97	IL 740	3/8 x 1 1/8	Panel Moulding	88
IL 426	1 1/16 x 1 5/8	Wainscot Cap	97	IL 741	3/4 x 1 1/8	Panel Moulding	88
IL 427	1 3/16 x 3 1/8	Chair Rail	94	IL 742	11/16 x 1 1/4	Panel Moulding	88
IL 428	1 5/16 x 3 3/16	Chair Rail	94	IL 743	1 x 1 5/16	Panel Moulding	88
IL 429	1 3/16 x 3 1/4	Chair Rail	95	IL 744	3/8 x 1 5/16	Panel Moulding	88
IL 430	1 5/8 x 3 7/16	Chair Rail	95	IL 745	3/4 x 1 3/8	Panel Moulding	88
IL 431	1 1/2 x 3 1/2	Wainscot Cap	97	IL 746	3/4 x 1 3/8	Panel Moulding	89
IL 432	1 9/16 x 3 3/4	Chair Rail	95	IL 747	3/4 x 1 7/16	Panel Moulding	89
IL 433	1 5/16 x 4	Chair Rail	95	IL 748	1 3/8 x 1 3/4	Panel Moulding	84, 89
IL 503	1 x Varies	Window Stool	102	IL 749	1 3/16 x 1 13/16	Panel Moulding	90
IL 504	1 1/16 x Varies	Window Stool	102	IL 750	1 x 2 1/16	Panel Moulding	90
IL 505	1 1/16 x Varies	Window Stool	102	IL 751	1 1/4 x 2 3/8	Panel Moulding	90
IL 510	5/8 x Varies	Window Stool	102	IL 752	3/4 x 2 3/16	Panel Moulding	91, 92
IL 511	1 3/8 x Varies	Window Stool	102	IL 753	1 1/4 x 3 5/16	Panel Moulding	91, 92
IL 512	1 3/8 x Varies	Window Stool	102	IL 810	13/16 x 2 1/8	Picture Moulding	98
IL 513	1 3/8 x Varies	Window Stool	102	IL 811	7/8 x 1 3/4	Picture Moulding	98
IL 514	1 1/16 x Varies	Window Stool	102	IL 813	1 x 1 1/2	Picture Moulding	98
IL 610	1 3/8 x 2 1/4	Capitol Moulding	82	IL 814	13/16 x 2 5/8	Picture Moulding	98
IL 615	11/16 x 1 3/4	Capitol Moulding	82	IL 910	11/16 x 4 1/2	Custom Boarding	100
IL 616	7/8 x 1 1/4	Capitol Moulding	82	IL 915	11/16 x 4 1/2	Custom Boarding	100
IL 619	7/8 x 1 1/8	Capitol Moulding	82	IL 916	11/16 x 4 1/2	Custom Boarding	100
IL 620	9/16 x 1 1/4	Capitol Moulding	82	IL 917	11/16 x 4 1/2	Custom Boarding	100
IL 621	15/16 x 1 1/8	Capitol Moulding	82	IL CRB1	3/4 x 7/8	Chair Rail Build-Out	96
IL 622	2 x 3	Solid Crown	86	IL CRB2	5/8 x 7/8	Chair Rail Build-Out	96
IL 623	1 7/16 x 2 1/2	Solid Crown	86	IL CRB3	1/2 x 7/8	Chair Rail Build-Out	96
IL 624	1 3/8 x 2 3/4	Solid Crown	86	IL E01	1 x 6 1/16	Ext. Crowns	113
IL 626	1 1/8 x 2 1/4	Solid Crown	86	IL E010	1/2 x 3/4	Ext. Panel Moulding	111
IL 627	1 1/8 x 2 1/4	Solid Crown	86	IL E011	11/16 x 1	Ext. Panel Moulding	111
IL 628	3/4 x 2	Solid Crown	86	IL E012	3/4 x 1 9/16	Ext. Panel Moulding	111
IL 631	3/4 x 7/8	Solid Crown	86	IL E013BB	1 5/8 x 1 1/4	Ext. Back Band	110
IL 632	3/4 x 1 1/8	Solid Crown	86	IL E01BB	1 13/16 x 1 15/16	Ext. Back Band	108
IL 633	1 3/8 x 2 3/4	Solid Crown	86	IL E02	1 1/16 x 5 7/8	Ext. Crowns	112
IL 634	1 3/4 x 2 3/8	Capitol Moulding	82	IL E02BB	1 9/16 x 1 13/16	Ext. Back Band	107
IL 635	1 13/16 x 2 7/8	Capitol Moulding	83	IL E03	1 1/8 x 7 1/2	Ext. Crowns	113
IL 636	1 5/8 x 2 7/8	Capitol Moulding	83, 84	IL E03BB	1 15/16 x 2 1/4	Ext. Back Band	109
IL 637	1 11/16 x 3 3/8	Capitol Moulding	83	IL E04	1 x 5 7/8	Ext. Crowns	112
IL 638	1 3/8 x 3 7/8	Capitol Moulding	83	IL E0444	3/4 x 3 1/2	Ext. Casing	109
IL 710	11/16 x 1 11/16	Panel Moulding	89	IL E0444B	3/4 x 3 1/2	Ext. Casing	109
IL 711	11/16 x 1 5/8	Panel Moulding	89	IL E05	11/16 x 4 1/2	Ext. Crowns	112
IL 712	11/16 x 1 1/2	Panel Moulding	89	IL E0544	1 1/16 x 3 1/2	Ext. Casing	107, 108, 110
IL 713	7/8 x 1 9/16	Panel Moulding	89	IL E0544B	1 1/16 x 3 1/2	Ext. Casing	107, 108, 110
IL 715	11/16 x 1 1/4	Panel Moulding	88	IL E06	15/16 x 4	Bed Moulding	114
IL 716	1/2 x 1 3/8	Panel Moulding	89	IL E07	1 x 4 5/8	Bed Moulding	114
IL 717	7/16 x 1 1/2	Panel Moulding	89	IL E08	1 3/8 x 2 1/4	Ext. Crowns	112
IL 718	7/16 x 1 3/8	Panel Moulding	89	IL E09	2 1/8 x 1 15/16	Brick Mould	111
IL 719	9/16 x 1 3/8	Panel Moulding	89	IL FAS1	3/4 x 5 1/2	Fascia Board	66
IL 720	3/8 x 1 1/4	Panel Moulding	88	IL FAS1	3/4 x 5 1/2	Fascia Board	67
IL 721	13/16 x 2 1/8	Panel Moulding	90	IL FAS2	3/4 x 5 1/2	Fascia Board	67
IL 725	1 3/16 x 1 13/16	Panel Moulding	90	IL MCS	2 1/8 x 4	Sub Sill	115
IL 728	3/8 x 1 1/8	Panel Moulding	88	IL MSSM	2 1/8 x 3 15/16	Sub Sill	115
IL 730	1/2 x 3/4	Panel Moulding	88	IL Quirk 1	1/2 x 1/2	Quirk	31
IL 731	1/2 x 3/4	Panel Moulding	88	IL Quirk 2	3/4 x 3/4	Quirk	31
IL 732	9/16 x 1 3/4	Panel Moulding	89	IL Quirk 3	1 x 1	Quirk	31
IL 733	9/16 x 1 1/8	Panel Moulding	88				



INTERIOR CROWNS SORTED BY DROP

IL#	BOARD DIMENSION	DROP	PROJECTION	PAGE(S)
IL 310	11/16 x 2	1 9/16	1 1/4	46
IL 329	11/16 x 2 3/4	1 15/16	2	46, 66
IL 322	7/8 x 2 3/4	2 5/16	1 1/2	46
IL 324	1 x 3 1/2	2 3/8	2 5/8	46
IL 313	11/16 x 2 7/8	2 7/16	1 5/8	46
IL 323	1 x 3 1/2	2 7/16	2 1/2	46
IL 350	11/16 x 3 5/16	2 9/16	2 3/16	46
IL 393	1 1/8 x 5	2 5/8	4 1/4	51, 80
IL 353	1 x 3 1/4	2 11/16	1 13/16	46
IL 328	1 x 3 1/2	2 11/16	2 1/4	46
IL 342	11/16 x 3 1/2	2 3/4	2 3/16	47, 68
IL 367	1 1/8 x 4 1/16	2 7/8	2 7/8	47, 70
IL 365	13/16 x 4	2 15/16	2 3/4	47, 69
IL 376	1 5/16 x 4 7/16	2 15/16	3 5/16	48, 73
IL 383	13/16 x 4 1/2	3 1/16	3 5/16	50, 76
IL 371	1 1/8 x 4 3/8	3 1/8	3 1/8	48, 71
IL 388	13/16 x 4 1/2	3 3/16	3 3/16	49, 78
IL 378	13/16 x 4 1/2	3 3/16	3 3/16	50, 74
IL 305	7/8 x 4 1/4	3 5/16	2 11/16	47
IL 311	11/16 x 4 1/2	3 5/16	3 1/16	49
IL 380	1 1/8 x 4 1/2	3 5/16	3 1/16	50, 75
IL 304	11/16 x 4 7/16	3 3/8	2 7/8	48, 72
IL 301	11/16 x 4 5/16	3 7/16	2 9/16	47
IL 386	13/16 x 4 1/2	3 7/16	2 15/16	49, 76
IL 362	7/8 x 4 3/8	3 1/2	2 5/8	47
IL 363	13/16 x 4 1/2	3 1/2	2 13/16	49, 68
IL 391	13/16 x 4 3/4	3 9/16	3 3/16	50, 79
IL 339	1 x 5	3 5/8	3 1/2	51
IL 327	1 1/4 x 6 7/8	3 5/8	5 7/8	57, 80
IL 348	13/16 x 4 3/8	3 11/16	2 3/8	48
IL 384	1 1/8 x 5 5/16	3 11/16	3 13/16	51, 76
IL 368	1 1/8 x 5 3/8	3 11/16	3 7/8	52, 70
IL 325	7/8 x 4 3/8	3 15/16	2	48
IL 352	15/16 x 5 1/8	3 15/16	3 1/4	51
IL 3771*	1 5/16 x 5 1/8	3 15/16	4 1/2	56
IL 3772*	1 9/16 x 1 1/4	3 15/16	4 1/2	56
IL 306	1 1/16 x 6	4 3/16	4 5/16	54
IL 361	1 x 6 1/16	4 3/16	4 3/8	56
IL 381	1 1/8 x 5 11/16	4 3/16	3 7/8	52, 75
IL 344	1 x 5 5/8	4 1/4	3 11/16	52
IL 389	13/16 x 6	4 1/4	4 1/4	53, 78
IL 379	1 1/8 x 6	4 1/4	4 1/4	54, 74
IL 372	1 5/16 x 6	4 1/4	4 1/4	55, 71
IL 303	1 x 5 5/8	4 5/16	3 5/8	52
IL 366	1 5/16 x 6	4 3/8	4 1/8	55, 69
IL 326	1 x 5 7/8	4 1/2	3 13/16	53, 68, 77
IL 374	1 1/8 x 6	4 9/16	3 7/8	55, 72
IL 369	1 5/16 x 6 1/2	4 9/16	4 5/8	57, 70
IL 321	1 1/16 x 5 7/8	4 5/8	3 5/8	53
IL 364	1 1/8 x 6	4 11/16	3 3/4	54, 68
IL 356	1 x 6 1/2	4 7/8	4 5/16	56, 79
IL 382	1 5/16 x 7	5 1/8	4 3/4	58, 75
IL 357	1 1/8 x 7 3/8	5 3/16	5 1/4	58, 73
IL 385	1 5/16 x 7 1/2	5 3/16	5 7/16	61, 76
IL 360	1 1/8 x 7 1/2	5 1/4	5 3/8	59
IL 358	1 3/4 x 7 1/2	5 5/16	5 5/16	60
IL 373	1 3/4 x 7 1/2	5 5/16	5 5/16	60, 71
IL 390	1 1/8 x 7 11/16	5 3/8	5 7/16	62, 78
IL 331	1 x 7 5/8	5 9/16	5 1/4	62
IL 370	1 3/4 x 8	5 5/8	5 11/16	63, 70
IL 387	1 1/8 x 7 1/2	5 11/16	4 7/8	59, 77
IL 375	1 5/16 x 7 1/2	5 3/4	4 13/16	61, 72
IL 354	1 1/4 x 6 3/4	5 13/16	4	57
IL 355	1 1/4 x 7 7/8	5 13/16	5 5/16	63
IL 392	1 5/16 x 8	5 15/16	5 5/16	64, 79
IL 345	1 1/2 x 8 1/2	6 3/16	5 13/16	64, 69
IL 359	1 5/16 x 8 7/8	6 11/16	5 7/8	65
IL 335	1 5/8 x 9 3/8	7 1/2	5 11/16	65

\*these 2 profiles join together to achieve this drop and projection

INTERIOR CROWNS SORTED BY PROJECTION

IL#	BOARD DIMENSION	DROP	PROJECTION	PAGE(S)
IL 310	11/16 x 2	1 9/16	1 1/4	46
IL 322	7/8 x 2 3/4	2 5/16	1 1/2	46
IL 313	11/16 x 2 7/8	2 7/16	1 5/8	46
IL 353	1 x 3 1/4	2 11/16	1 13/16	46
IL 325	7/8 x 4 3/8	3 15/16	2	48
IL 329	11/16 x 2 3/4	1 15/16	2	46, 66
IL 342	11/16 x 3 1/2	2 3/4	2 3/16	47, 68
IL 350	11/16 x 3 5/16	2 9/16	2 3/16	46
IL 328	1 x 3 1/2	2 11/16	2 1/4	46
IL 348	13/16 x 4 3/8	3 11/16	2 3/8	48
IL 323	1 x 3 1/2	2 7/16	2 1/2	46
IL 301	11/16 x 4 5/16	3 7/16	2 9/16	47
IL 324	1 x 3 1/2	2 3/8	2 5/8	46
IL 362	7/8 x 4 3/8	3 1/2	2 5/8	47
IL 305	7/8 x 4 1/4	3 5/16	2 11/16	47
IL 365	13/16 x 4	2 15/16	2 3/4	47, 69
IL 363	13/16 x 4 1/2	3 1/2	2 13/16	49, 68
IL 367	1 1/8 x 4 1/16	2 7/8	2 7/8	47, 70
IL 304	11/16 x 4 7/16	3 3/8	2 7/8	48, 72
IL 386	13/16 x 4 1/2	3 7/16	2 15/16	49, 77
IL 311	11/16 x 4 1/2	3 5/16	3 1/16	49
IL 380	1 1/8 x 4 1/2	3 5/16	3 1/16	50, 75
IL 381	1 1/8 x 4 3/8	3 1/8	3 1/8	48, 71
IL 388	13/16 x 4 1/2	3 3/16	3 3/16	49, 78
IL 378	13/16 x 4 1/2	3 3/16	3 3/16	50, 74
IL 391	13/16 x 4 3/4	3 9/16	3 3/16	50, 79
IL 352	15/16 x 5 1/8	3 15/16	3 1/4	51
IL 376	1 5/16 x 4 7/16	2 15/16	3 5/16	48, 73
IL 383	13/16 x 4 1/2	3 1/16	3 5/16	50, 76
IL 339	1 x 5	3 5/8	3 1/2	51
IL 327	1 1/4 x 6 7/8	3 5/8	5 7/8	57, 80
IL 344	1 x 5 5/8	4 1/4	3 11/16	52
IL 364	1 1/8 x 6	4 11/16	3 3/4	54, 68
IL 384	1 1/8 x 5 5/16	3 11/16	3 13/16	51, 76
IL 326	1 x 5 7/8	4 1/2	3 13/16	53, 68, 77
IL 368	1 1/8 x 5 3/8	3 11/16	3 7/8	52, 70
IL 381	1 1/8 x 5 11/16	4 3/16	3 7/8	52, 75
IL 374	1 1/8 x 6	4 9/16	3 7/8	55, 72
IL 354	1 1/4 x 6 3/4	5 13/16	4	57
IL 366	1 5/16 x 6	4 3/8	4 1/8	55, 69
IL 393	1 1/8 x 5	2 5/8	4 1/4	51, 80
IL 389	13/16 x 6	4 1/4	4 1/4	53, 78
IL 379	1 1/8 x 6	4 1/4	4 1/4	54, 74
IL 372	1 5/16 x 6	4 1/4	4 1/4	55, 71
IL 306	1 1/16 x 6	4 3/16	4 5/16	54
IL 356	1 x 6 1/2	4 7/8	4 5/16	56, 79
IL 361	1 x 6 1/16	4 3/16	4 3/8	56
IL 3771*	1 5/16 x 5 1/8	3 15/16	4 1/2	56
IL 3772*	1 9/16 x 1 1/4	3 15/16	4 1/2	56
IL 369	1 5/16 x 6 1/2	4 9/16	4 5/8	57, 70
IL 382	1 5/16 x 7	5 1/8	4 3/4	58, 75
IL 375	1 5/16 x 7 1/2	5 3/4	4 13/16	61, 72
IL 387	1 1/8 x 7 1/2	5 11/16	4 7/8	59, 77
IL 331	1 x 7 5/8	5 9/16	5 1/4	62
IL 357	1 1/8 x 7 3/8	5 3/16	5 1/4	58, 73
IL 358	1 3/4 x 7 1/2	5 5/16	5 5/16	60
IL 355	1 1/4 x 7 7/8	5 13/16	5 5/16	63
IL 390	1 1/8 x 7 11/16	5 3/8	5 7/16	62, 78
IL 392	1 5/16 x 8	5 15/16	5 5/16	64, 79
IL 360	1 1/8 x 7 1/2	5 1/4	5 3/8	59
IL 385	1 5/16 x 7 1/2	5 3/16	5 7/16	61, 76
IL 390	1 1/8 x 7 11/16	5 3/8	5 7/16	62, 78
IL 335	1 5/8 x 9 3/8	7 1/2	5 11/16	65
IL 370	1 3/4 x 8	5 5/8	5 11/16	63, 70
IL 345	1 1/2 x 8 1/2	6 3/16	5 13/16	64, 69
IL 359	1 5/16 x 8 7/8	6 11/16	5 7/8	65
IL 327	1 1/4 x 6 7/8	3 5/8	5 7/8	57, 80

\*these 2 profiles join together to achieve this drop and projection



